

FIX-IT

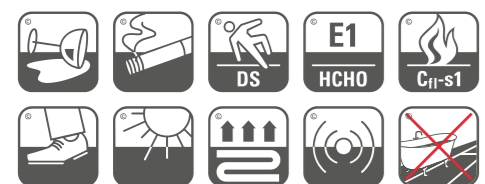

produced and tested in compliance with EN 13329



Verlegung
La Pose
La Posa
Laying
Colocacion

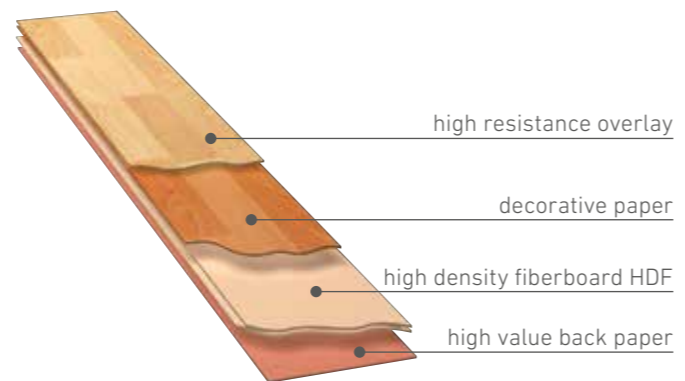
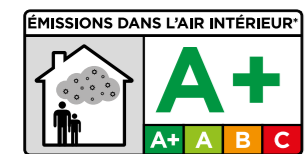

EN 14041:2005

DE – Alle unsere Premium-Laminatfußböden haben sehr individuelle und einzigartige Planken. Für den Besten «Echt-holz-Effekt» empfehlen wir die Planken vor dem Verlegen anzuschauen und eine Vorauswahl zu treffen.

EN – All our premium laminates have very individual and distinctive planks. For best „real wood“ effect on complete floor area, planks should be preselected before laying.

FR – Tous nos sols stratifiés « Premium » sont exclusifs et uniques. Afin d'atteindre au mieux un effet « parquet bois » sur toute la surface du sol, les lames doivent être triées et sélectionnées avant la pose.

IT – Tutti i nostri laminati premium sono composti da doghe uniche e molto particolari. Per ottenere il miglior effetto „legno reale“ su un'area completa, i pannelli devono essere preselezionati prima della posa.

PT – A nossa gama de pavimentos premium é constituída por régua individuais e muito distintas. Para o melhor efeito de „madeira natural“ na área a instalar, as régua devem ser pré-selecionadas antes da instalação definitiva.

ES – Nuestra gama de suelos premium está constituída por tablas individuales y muy distintas. Para el mejor efecto de la „madera natural“ en el área a instalar, las tablas deben ser preseleccionadas antes de la instalación definitiva.

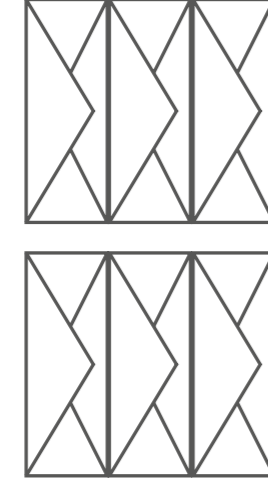

IMPORTANT INFORMATION

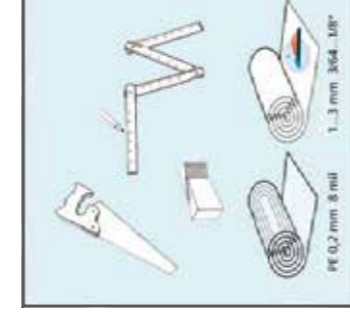
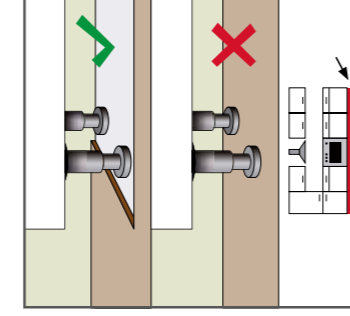
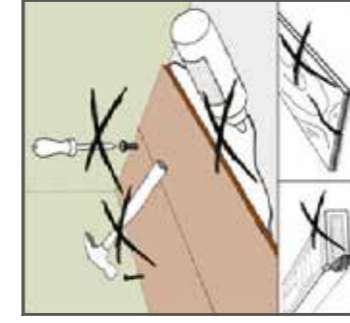
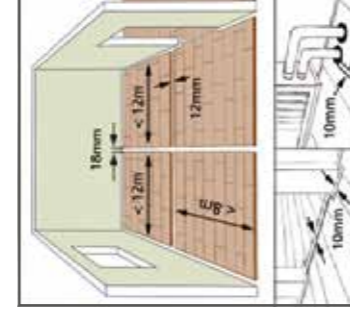
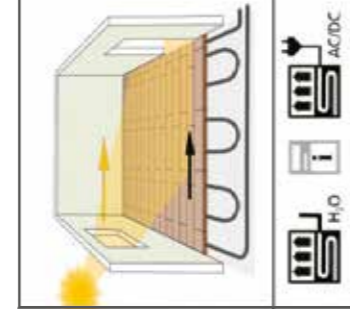
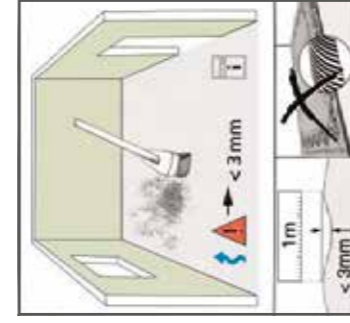

INSTALLATION

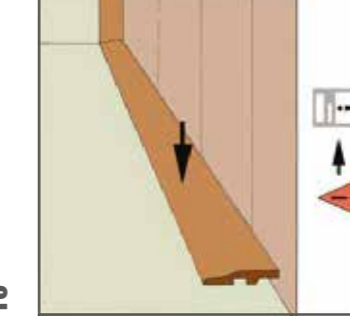
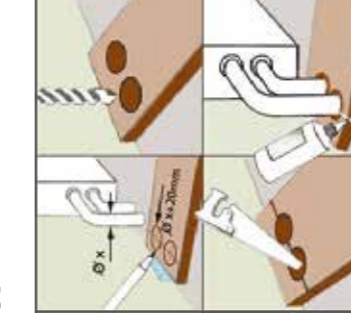
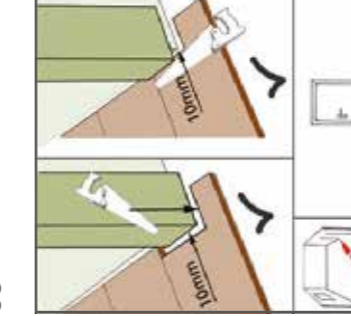
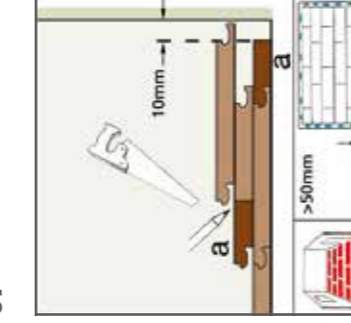
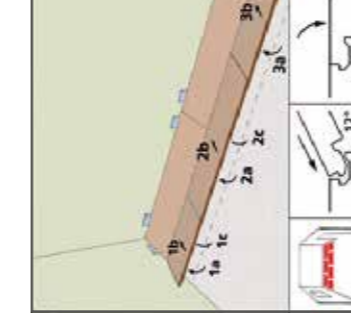
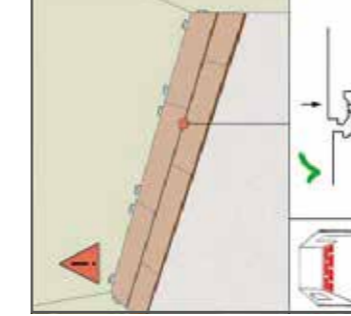
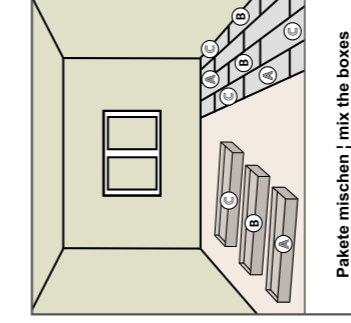
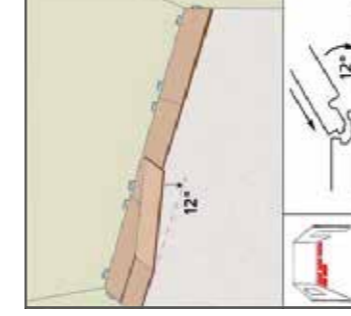
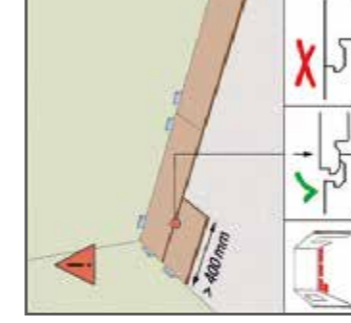
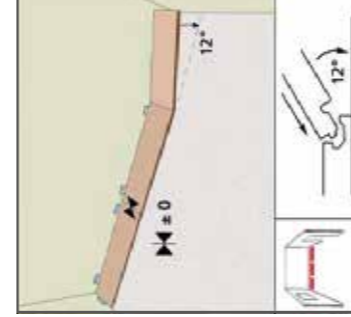
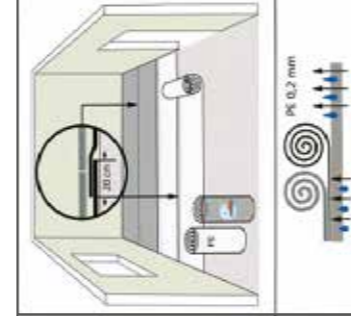

13

CARE

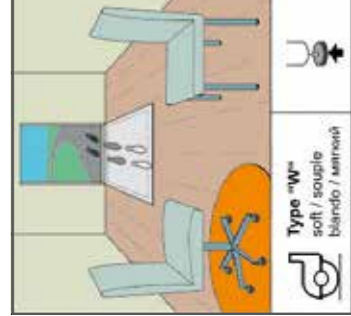
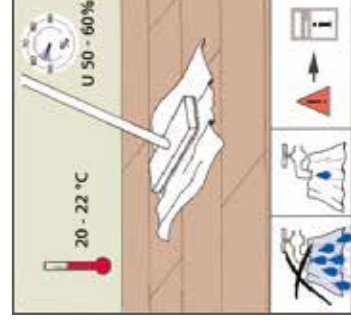

WARNING: Drilling, sawing, sanding or machining wood products can expose you to wood dust, a substance known to the State of California to cause cancer. Avoid inhaling wood dust or use a dust mask or other safeguards for personal protection. For more information go to www.P65Warnings.ca.gov/wood.



ADVERTENCIA: Los productos para taladrar, aserrar, lijar o cortar madera pueden exponerlo al polvo de madera, una sustancia reconocida por el estado de California como causante de cáncer. Evite inhalar el polvo de la madera o utilice una máscara u otros artículos de protección personal. Para obtener más información, visite www.P65Warnings.ca.gov/wood.



AVERTISSEMENT: Le perçage, le sciage, le ponçage et l'usinage des produits en bois peut vous exposer à de la poussière de bois, une substance reconnue par l'État de la Californie comme étant la cause de cancers. Évitez d'inhaler la poussière de bois ou utilisez un masque antipoussières ou d'autres mesures de sécurité pour vous protéger. Pour plus de renseignements, rendez-vous au www.P65Warnings.ca.gov/wood.