

Art. Nr. 2847296

1/7

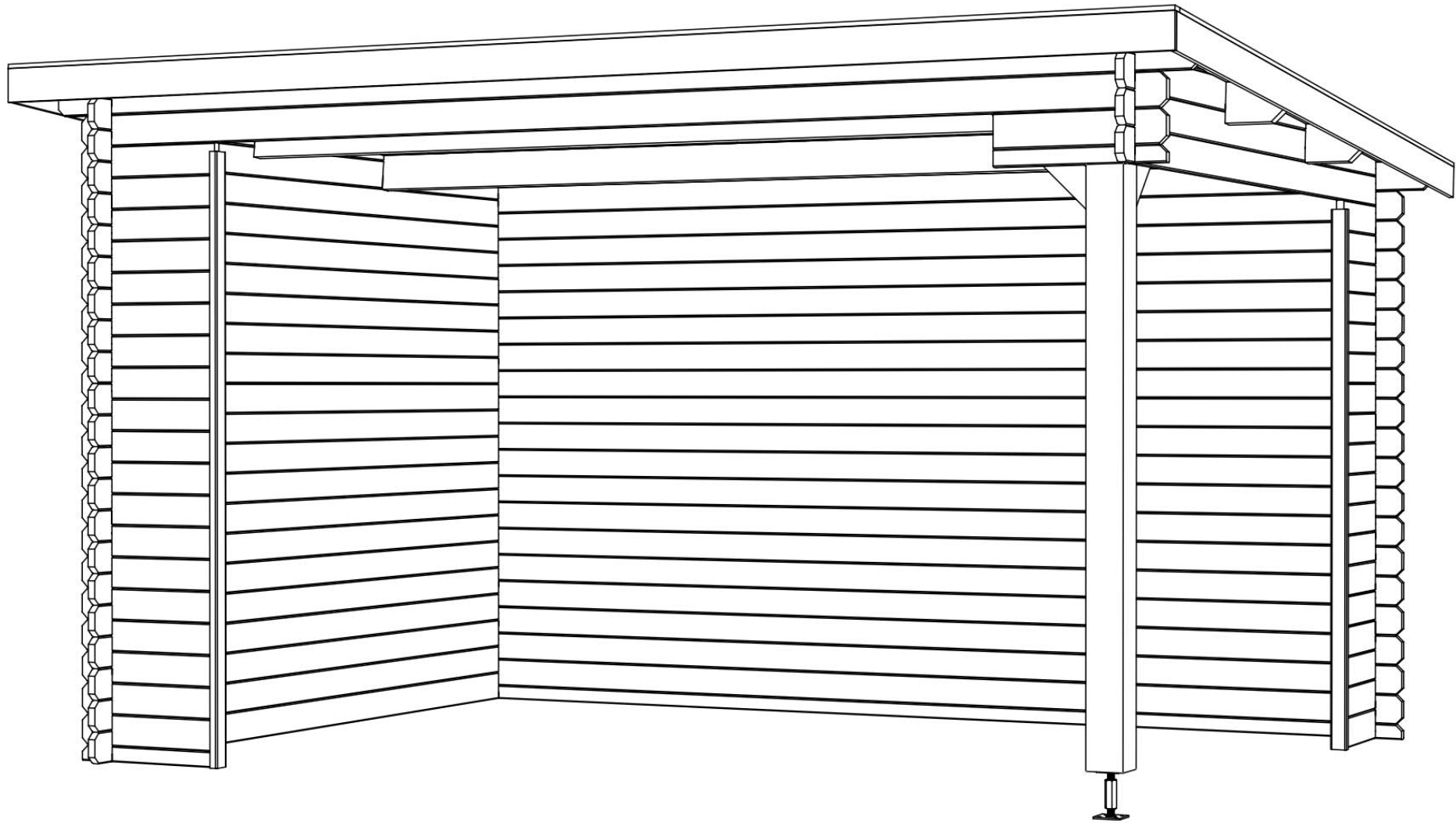

22/10/2023

Art. Nr. 2847296

Groundplan - Grundplan - Plan de masse - Planimetria - Plattegrond - Põhiplaan

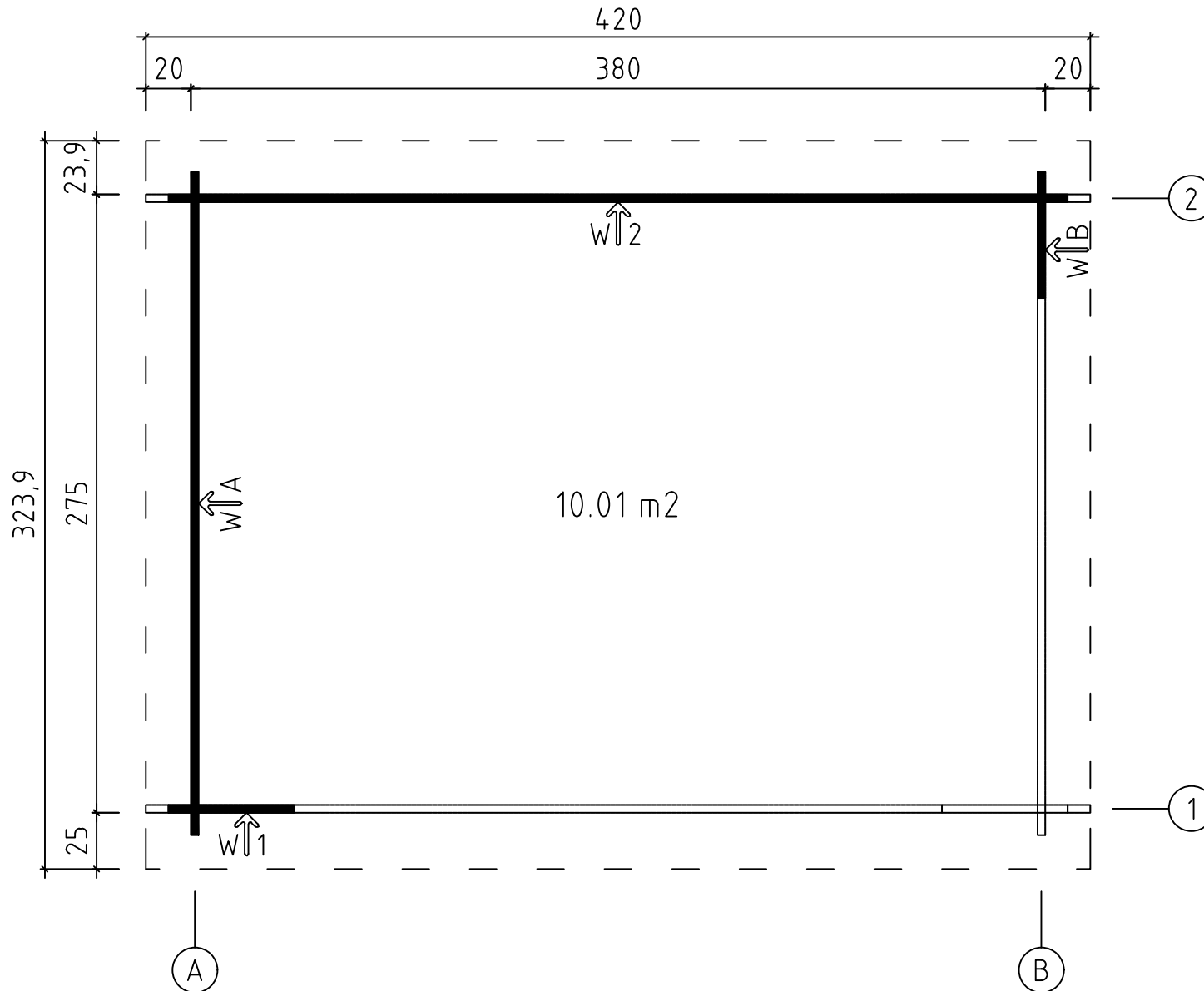



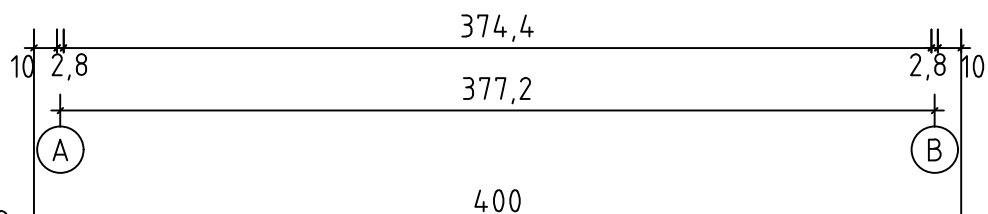
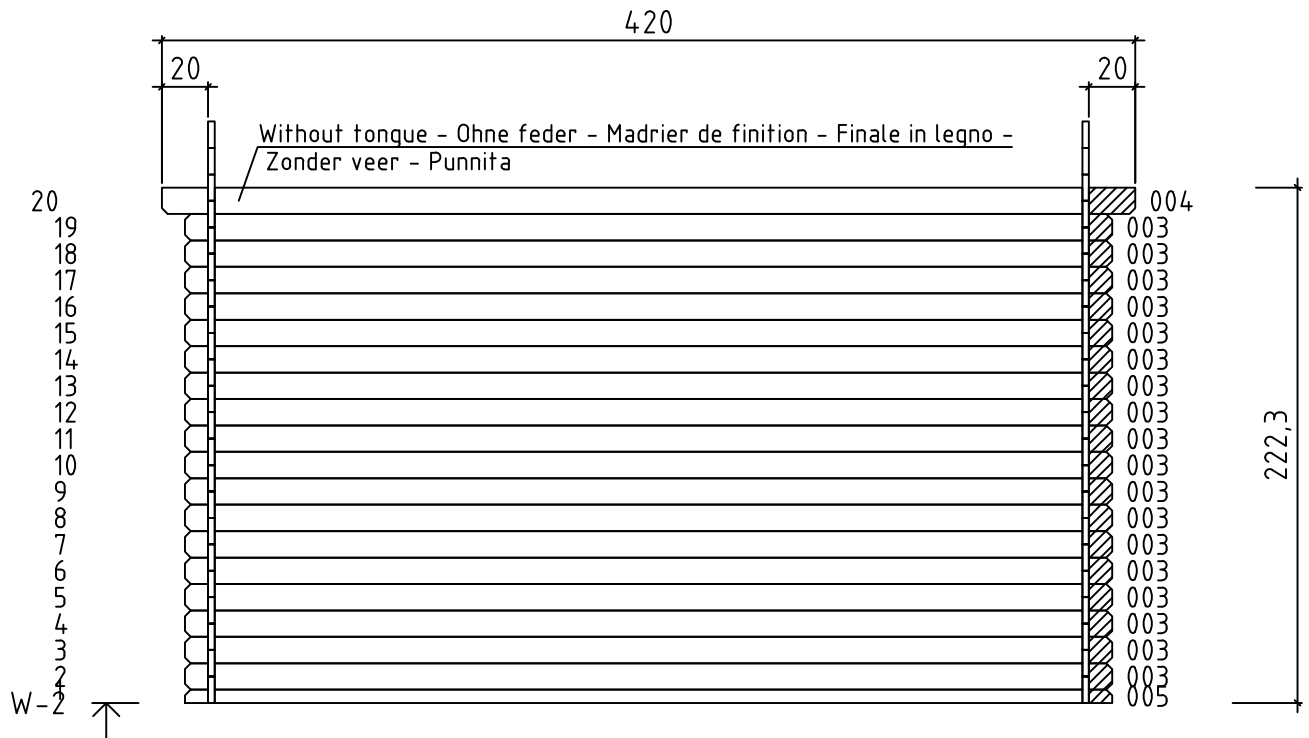
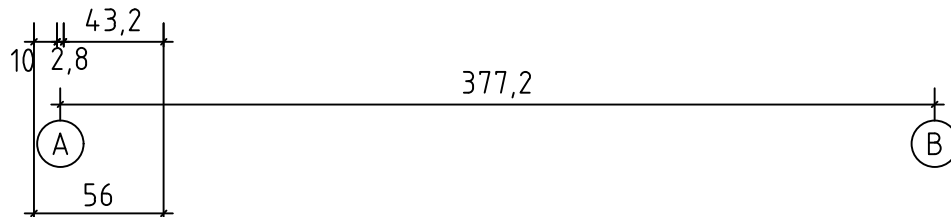
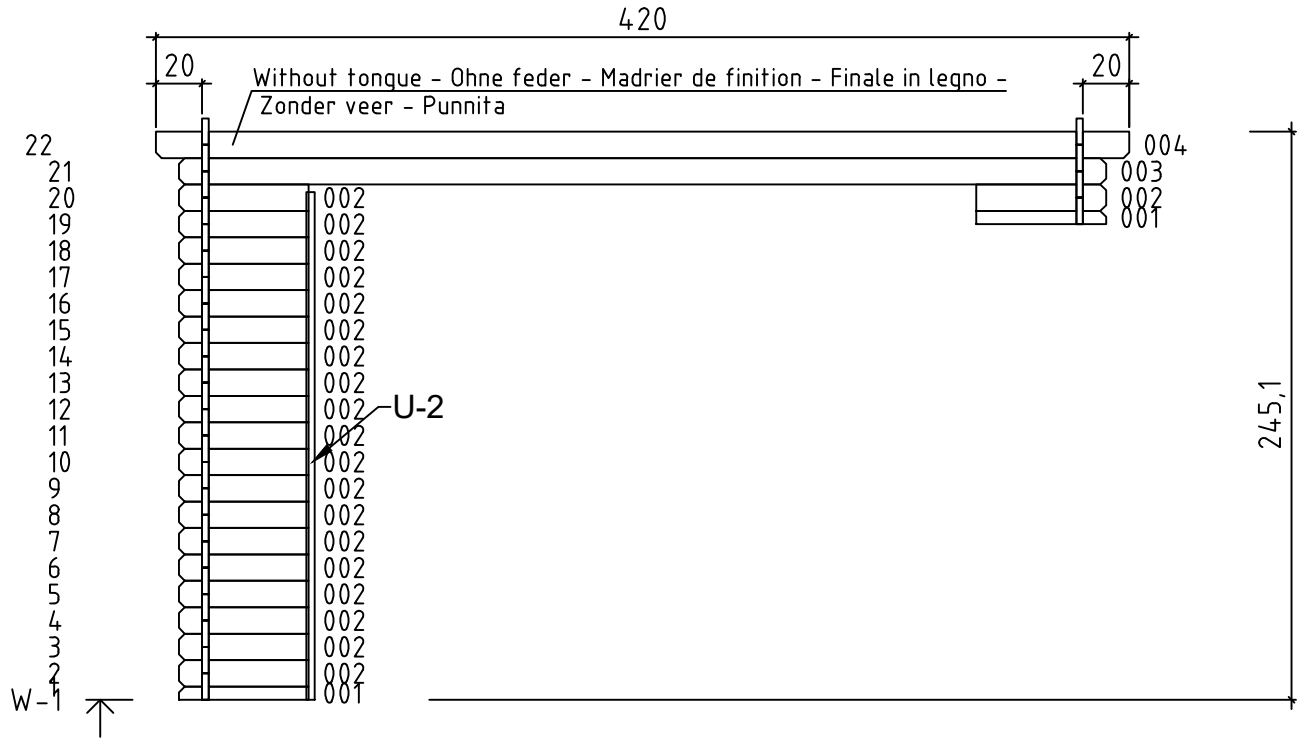



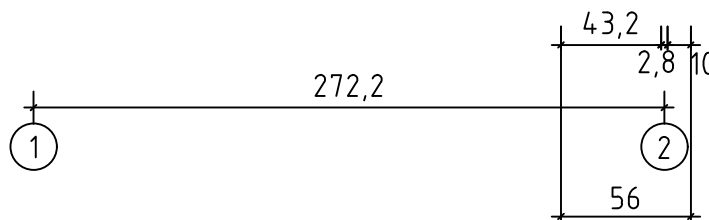
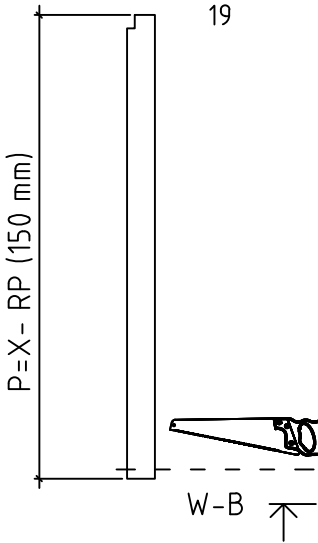
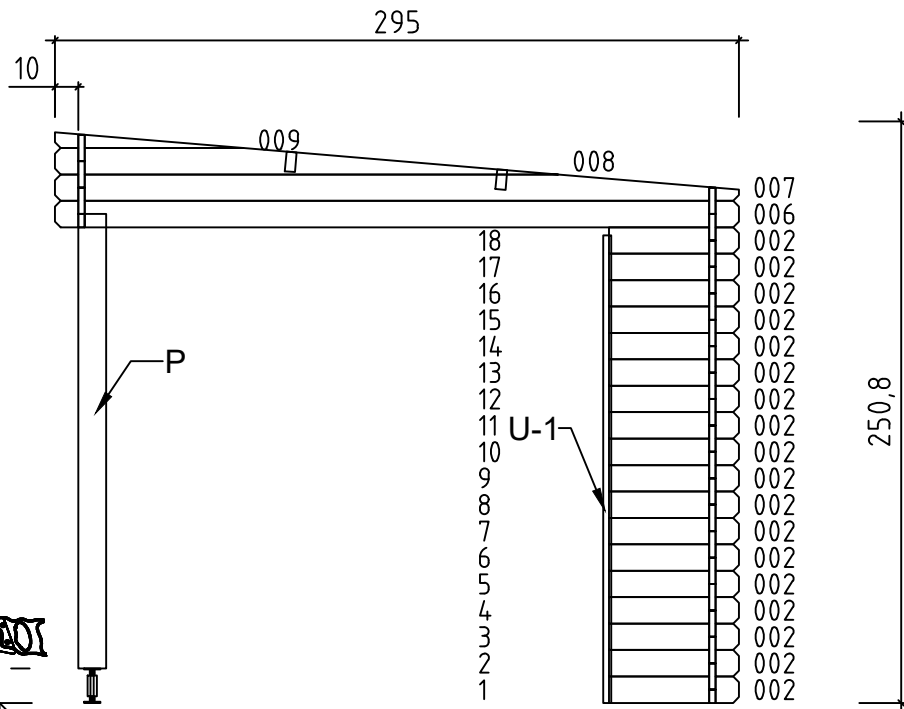
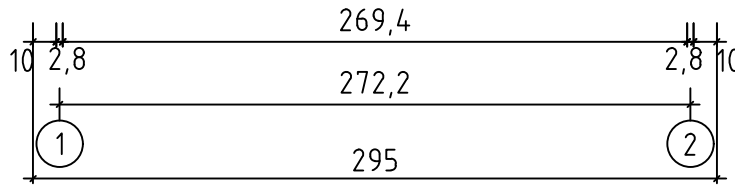
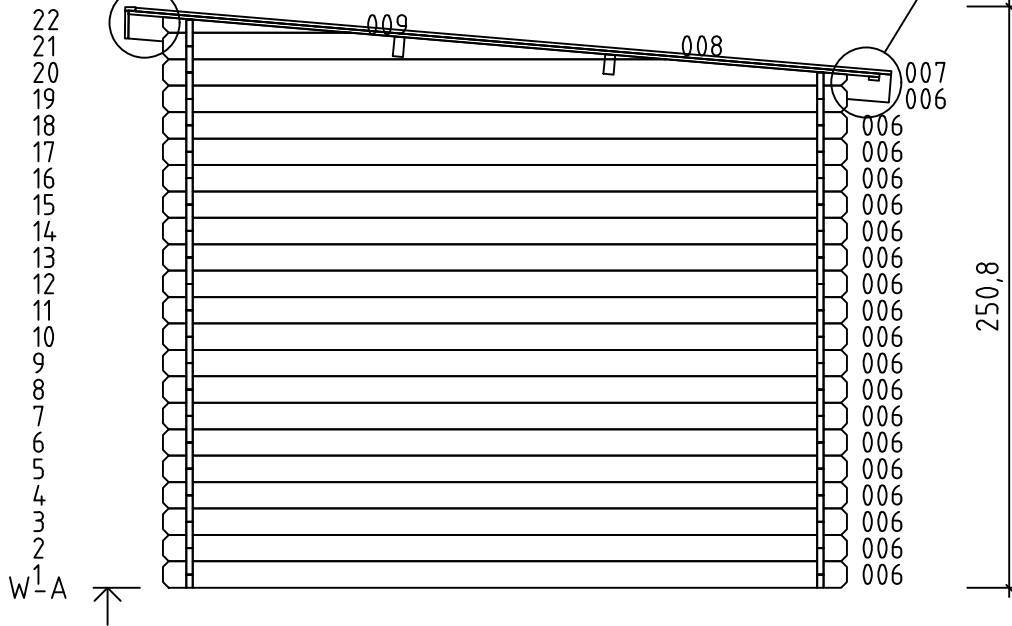
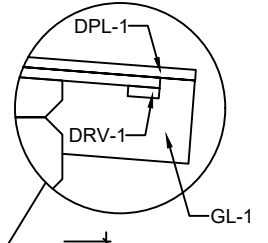
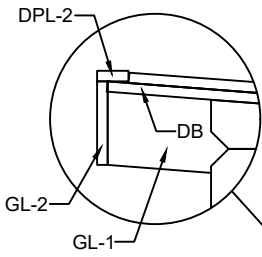

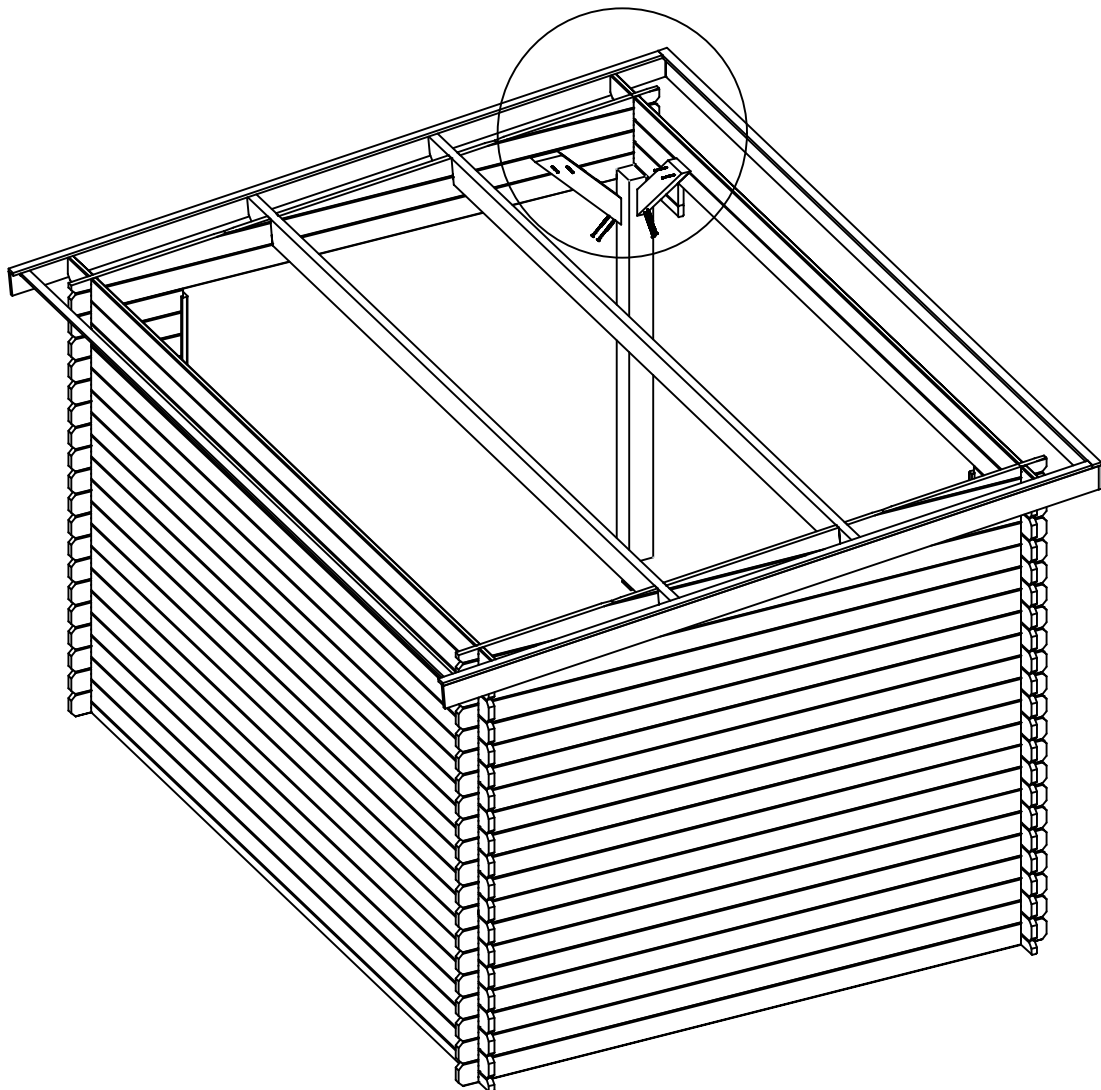
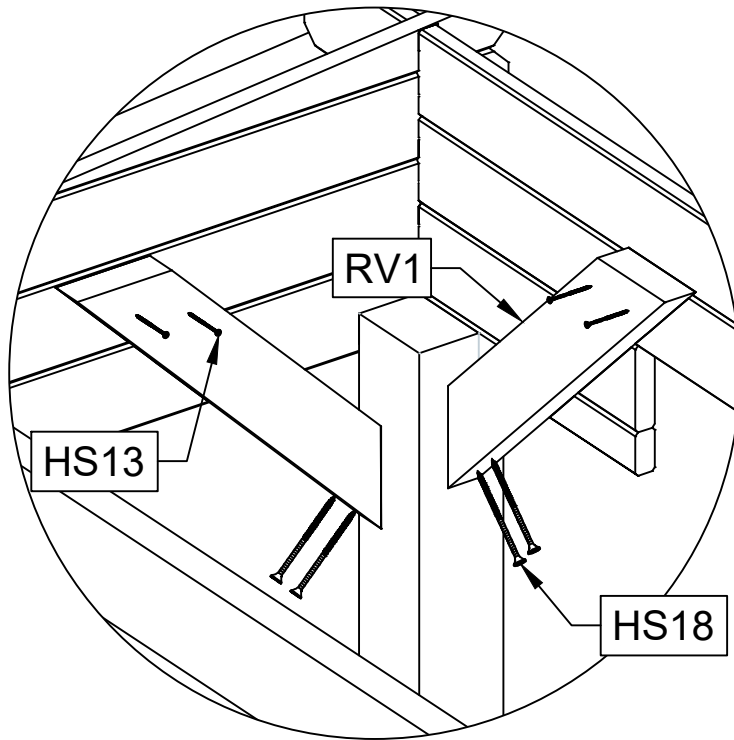

Art. Nr. 2847296

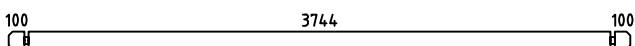
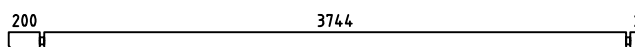
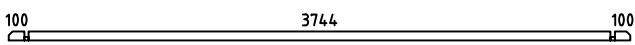
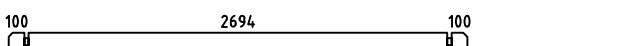
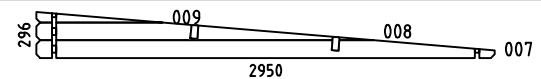
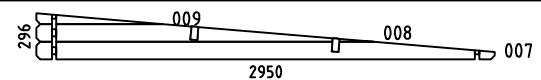
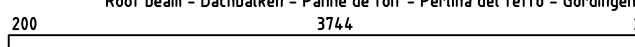
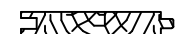
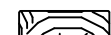
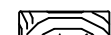
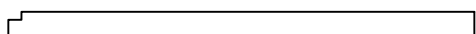
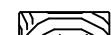

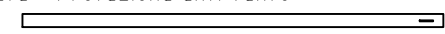
Art. Nr. 2847296

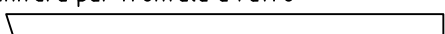
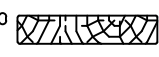



| Pos | 22.10.2023 Piece list - Stückliste - Liste des pièces - Elementi - Stuklijst - Tükítabel Art. Nr. 2847296 6/7 | Q | P (mm) | L (mm) |
|-------|---|----|-----------|-----------|
| 001 |  | 2 | 28x57 | 560 |
| 002 |  | 38 | 28x114 | 560 |
| 003 |  | 19 | 28x114 | 4000 |
| 004 |  | 2 | 28x114 | 4200 |
| 005 |  | 1 | 28x57 | 4000 |
| 006 |  | 20 | 28x114 | 2950 |
| WA-1 |  | 1 | | |
| WB-1 |  | 1 | | |
| A-PR1 | Roof beam - Dachbalken - Panne de toit - Perlina del tetto - Gordingen / dakbalk - Pärтин  | 2 | 44x146 | 4200 |
| DB | Roof boards - Dachbretter - Voliges - Perlina per tetto - Dakhout - Katuselaud  | 47 | 90x15,5 | 3250 |
| DPL-1 | Roofing felt fillet - Dachpappenleiste - Baguette de fixation du feutre bitumeux - Asse per fissaggio guaina bituminosa - Afdekljst asfaltpapier - Katusepapiilist  | 2 | 15x45 | 3270 |
| DPL-2 | Roofing felt fillet - Dachpappenleiste - Baguette de fixation du feutre bitumeux - Asse per fissaggio guaina bituminosa - Afdekljst asfaltpapier - Katusepapiilist  | 1 | 15x45 | 4230 |
| P | Post - Pfosten - Poteau - Piede registrabile - Stijl - Post  | 1 | 120x120 | 2000 |
| DRV-1 | Roof edge reinforcement - Dachrandverstärkung - Corniere de renfort de bord de toit - Rinforzo x tetto - Dakrand versterking - Räästatugevdus  | 1 | 15x45 | 4200 |
| BL | Beam - Balkenlage - Solive(s) - Trave - Balk (gording) - Tala  | 2 | 44x120 | 620 |
| KFS-1 | Storm protection - Sturmleiste - Latte anti-tempete - Protezione anti vento - Stormverankering / beveiliging - Tormikinnitusliist  | 3 | 22x45 | 2500 |
| U-1 | U-profile - U-profils - Profile u - Profilo ad u - U-profiel - U-profiil  | 1 | 28x58 | 2017 |
| U-2 | U-profile - U-profils - Profile u - Profilo ad u - U-profiel - U-profiil  | 1 | 28x58 | 2190 |
| GL-1 | Gable moulding - Giebelleiste - Planche de rive - Finitura per frontale e retro del tetto - Gevellijst - Viilulaud  | 2 | 15x120 | 3300 |
| GL-2 | Gable moulding - Giebelleiste - Planche de rive - Finitura per frontale e retro del tetto - Gevellijst - Viilulaud  | 1 | 15x120 | 4230 |
| HS9 | Screw for u-profile - Schraube zur befestigung u-profils - Vis a tete fraisée pour profil u - Vite per profilo ad u - Schroef ter bevestiging u-profiel - Kruvi U-profiilile  | 12 | 3.5x50 | |
| HS9 | Screw for gable moulding - Schrauben für giebelleiste - Vis pour fixation planche de rive - Vite per fissare finiture davanti e dietro del tetto - Schroef voor gevellijst - Kruvi viilulauale  | 24 | 3.5x50 | |
| HS4 | Screw for roof edge reinforcement - Schrauben für dachrandverstärkung - Vis pour fixation corniere renfort de bord de toit - Viti x rinforzo bordo tetto - Schroef voor dakrand versterking - Kruvi räästatugevdusele  | 7 | 3x30 | |

