

# TRY

6939101330



User manual  
Bedienungsanleitung  
Mode d'emploi  
Handleiding  
Manuale  
Manual del usuario  
Használati utasítás  
Instrukcja obsługi



# LUTEC

**Incl.**

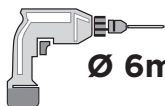
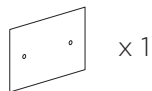
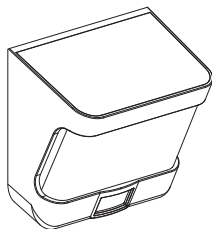

Ø 6mm

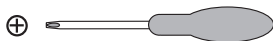

# Installation

Installation/Installation/Instalación/Installazione  
Installatie/Instalacja/Telepités

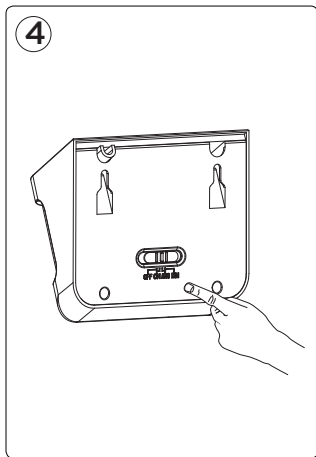
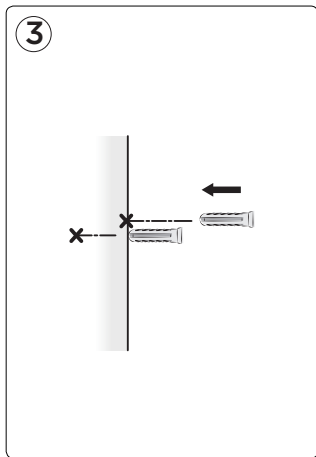
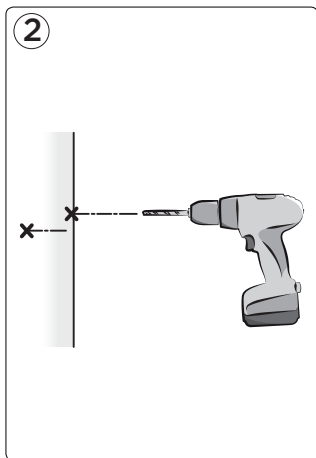
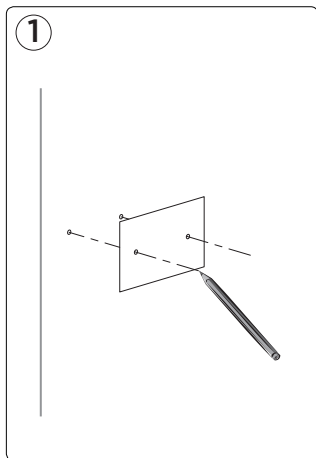

5

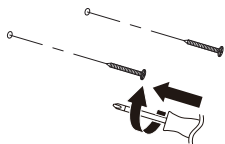

6

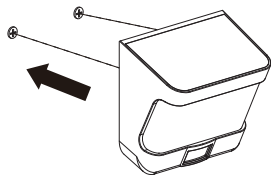

## First Use

Erste Verwendung/Première utilisation/Eerste gebruik/Primo utilizzo  
Primer uso/Első használat/Pierwsze użycie



It is recommended to put the solar panel in the sun for 8 hours to charge the battery.

Es wird empfohlen, das Solarpanel 8 Stunden lang in die Sonne zu legen, um den Akku aufzuladen.

Il est recommandé de placer le panneau solaire au soleil pendant 8 heures pour charger la batterie.

Het wordt aanbevolen om het zonnepaneel 8 uur in de zon te laten staan om de batterij op te laden.

Si consiglia di mettere il pannello solare sotto il sole per 8 ore per caricare la batteria.

Se recomienda colocar el panel solar al sol durante 8 horas para cargar la batería.

Javasoljuk, hogy a napelemet 8 órán keresztül a napsütésben töltsse fel az akkumulátor feltöltéséhez.

Zaleca się umieszczenie panelu słonecznego na słońcu na 8 godzin, aby naładować akumulator.

## Function

Funktion/Fonction/Functie/Funzione  
Función/Funkció/Funkcja

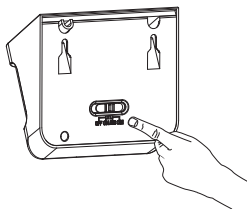

1 Max. 100times AUTO

2 Max. 100times DIM

3 10h ON

4 OFF

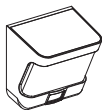

At dusk, the motion sensor becomes active.

Any movement within the detection reach will switch-on the light. The light stays on for 30 sec. At dawn, the motion sensor will deactivate.

In der Dämmerung wird der Bewegungssensor aktiv.

Jede Bewegung innerhalb der Erfassungsreichweite schaltet das Licht ein.

Das Licht bleibt für 30 sek an. Im Morgengrauen wird der Bewegungssensor deaktiviert.

Au crépuscule, le détecteur de mouvement devient actif.

Tout mouvement dans la portée de détection allumera la lumière. La lumière reste allumée pendant 30 secondes. À l'aube, le détecteur de mouvement se désactivera.

In de schemering wordt de bewegingssensor actief.

Elke beweging binnen het detectiebereik zal het licht inschakelen. Het licht blijft 30 sec branden. Bij zonsopgang wordt de bewegingsopnemer gedeactiveerd.

Al tramonto, il sensore di movimento diventa attivo.

Qualsiasi movimento all'interno della portata di rilevamento accenderà la luce. La luce rimane accesa per 30 sec. All'alba, il sensore di movimento si disattiverà.

Al anochecer, el sensor de movimiento se activa.

Cualquier movimiento dentro del alcance de detección encenderá la luz. La luz permanece encendida durante 30 seg. Al amanecer, el sensor de movimiento se desactivará.

Alkonyatkor a mozgásérzékelő aktívvá válik.

Bármely mozgás a detektálási határon belül bekapcsolja a fényt. A fény 30 mp marad. Hajnalban a mozgásérzékelő kikapcsol.

O zmierzchu czujnik ruchu staje się aktywny.

Każdy ruch w zasięgu wykrywania spowoduje włączenie światła. Światło pozostaje włączone przez 30 sek. O świcie czujnik ruchu wyłączy się.

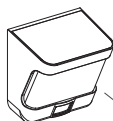
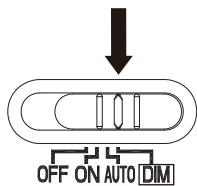
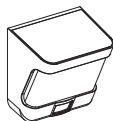
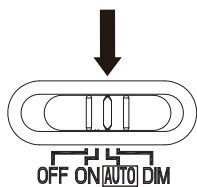
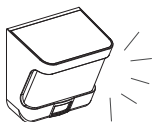
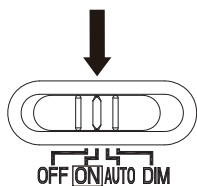

# Safety

Safety:	<ul style="list-style-type: none"><li>• Do not expose the light to fire or intense heat.</li><li>• Do not immerse the light into water.</li><li>• Keep the solar panel clean.</li></ul>
Sicherheit:	<ul style="list-style-type: none"><li>• Setzen Sie das Licht weder Feuer noch starker Hitze aus.</li><li>• Tauchen Sie das Licht nicht in Wasser.</li><li>• Halten Sie das Solarpanel sauber.</li></ul>
Sécurité:	<ul style="list-style-type: none"><li>• Veuillez ne pas exposer la lumière à un feu ou à une chaleur intense.</li><li>• Veuillez ne pas immerger la lumière dans l'eau.</li></ul>
Seguridad:	<ul style="list-style-type: none"><li>• Veuillez garder le panneau solaire propre.</li><li>• No exponga la luz al fuego o calor intenso.</li><li>• No sumerja la luz en el agua.</li><li>• Mantenga el panel solar limpio.</li></ul>
Sicurezza:	<ul style="list-style-type: none"><li>• Non esporre la luce a fiamme o calore intenso.</li><li>• Non immergere la luce nell'acqua.</li><li>• Mantenere pulito il pannello solare.</li></ul>
Veiligheid:	<ul style="list-style-type: none"><li>• Stel het licht niet bloot aan vuur of intense hitte.</li><li>• Dompel het licht niet onder in water.</li><li>• Houd het zonnepaneel schoon.</li></ul>
Bezpieczeństwo:	<ul style="list-style-type: none"><li>• Nie należy poddawać lampki na bezpośrednie działanie ognia lub intensywnego ciepła.</li><li>• Nie należy zanurzać lampki w wodzie.</li><li>• Panel słoneczny należy utrzymywać w czystości.</li></ul>
Biztonság:	<ul style="list-style-type: none"><li>• Ne tegye ki a lámpát tűznek vagy intenzív hőhatásnak.</li><li>• Ne merítse a lámpát vízbe.</li><li>• Tartsa tisztán a napelemet.</li></ul>



## LUTEC Europe NV

Herentalsebaan 425

B-2160 Wommelgem - Belgium

+32 3 284 51 62

info@lutec-europe.com

www.lutec.com



[www.lutec.com/services/global-network](http://www.lutec.com/services/global-network)