

FLAIR

5288804012



User manual
Bedienungsanleitung
Mode d'emploi
Handleiding
Manuale
Manual del usuario
Használati utasítás
Instrukcja obsługi



LUTEC

Incl.

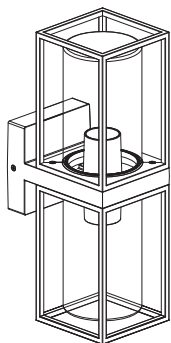

x 4



x 4

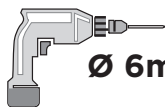

Ø 6mm



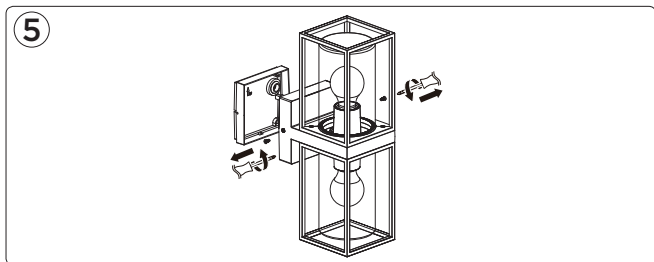
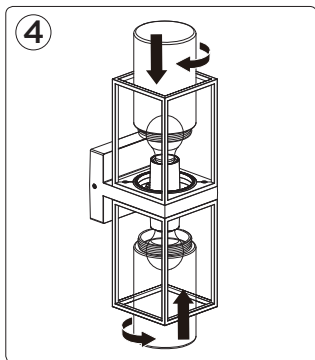
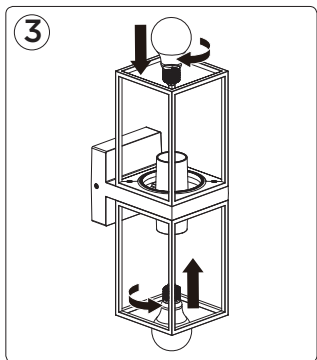
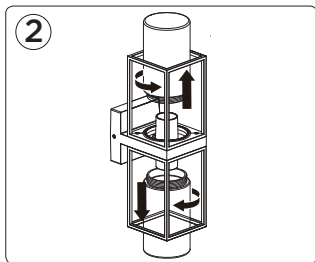
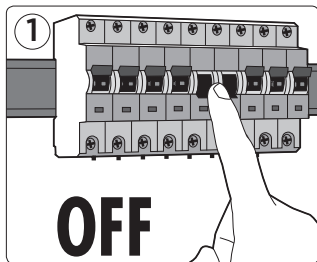

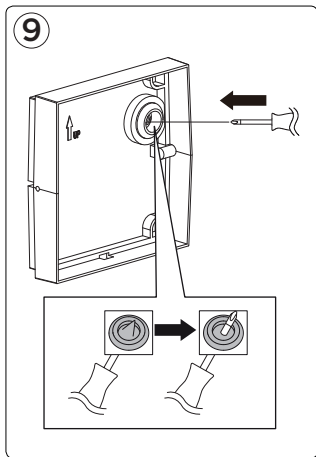
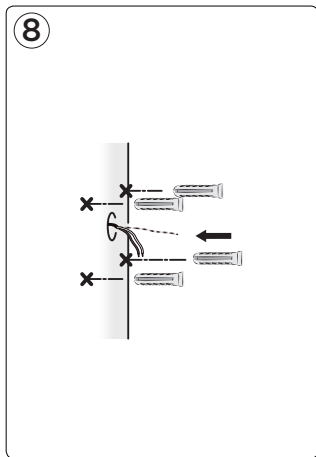
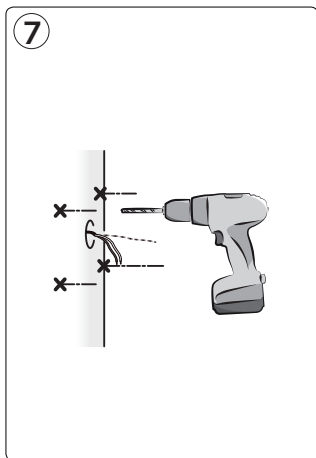
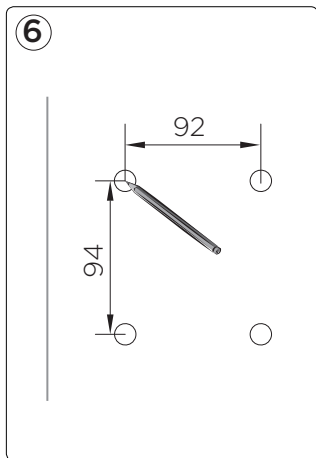

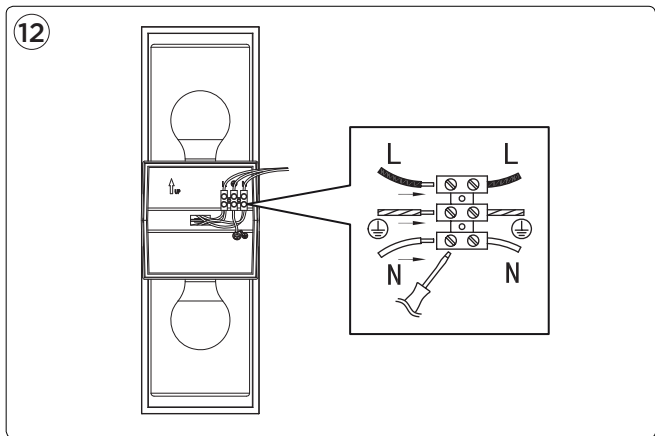
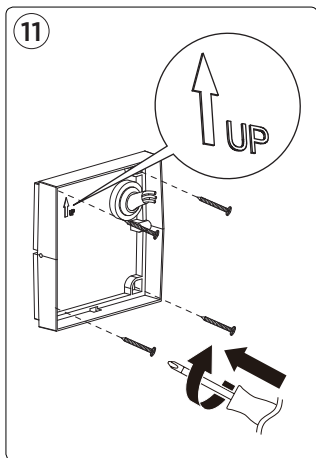
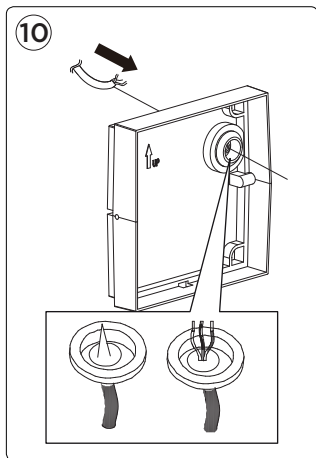

13

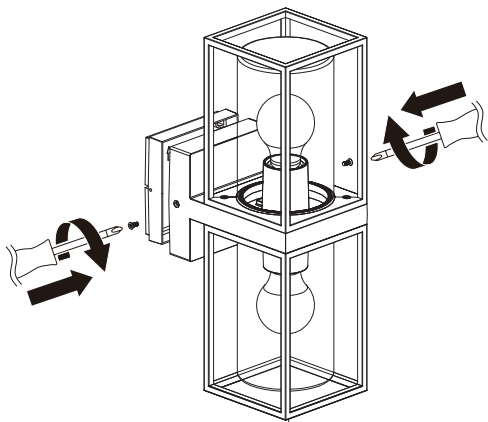



LUTEC Europe NV

Herentalsebaan 425
B-2160 Wommelgem - Belgium
+32 3 284 51 62
info@lutec-europe.com
www.lutec.com



www.lutec.com/services/global-network