

# compact

Montage instructie  
Assembling instruction  
Montageanleitung  
Instructions de montage  
Emballage instruktioner  
Instrukcja montażu

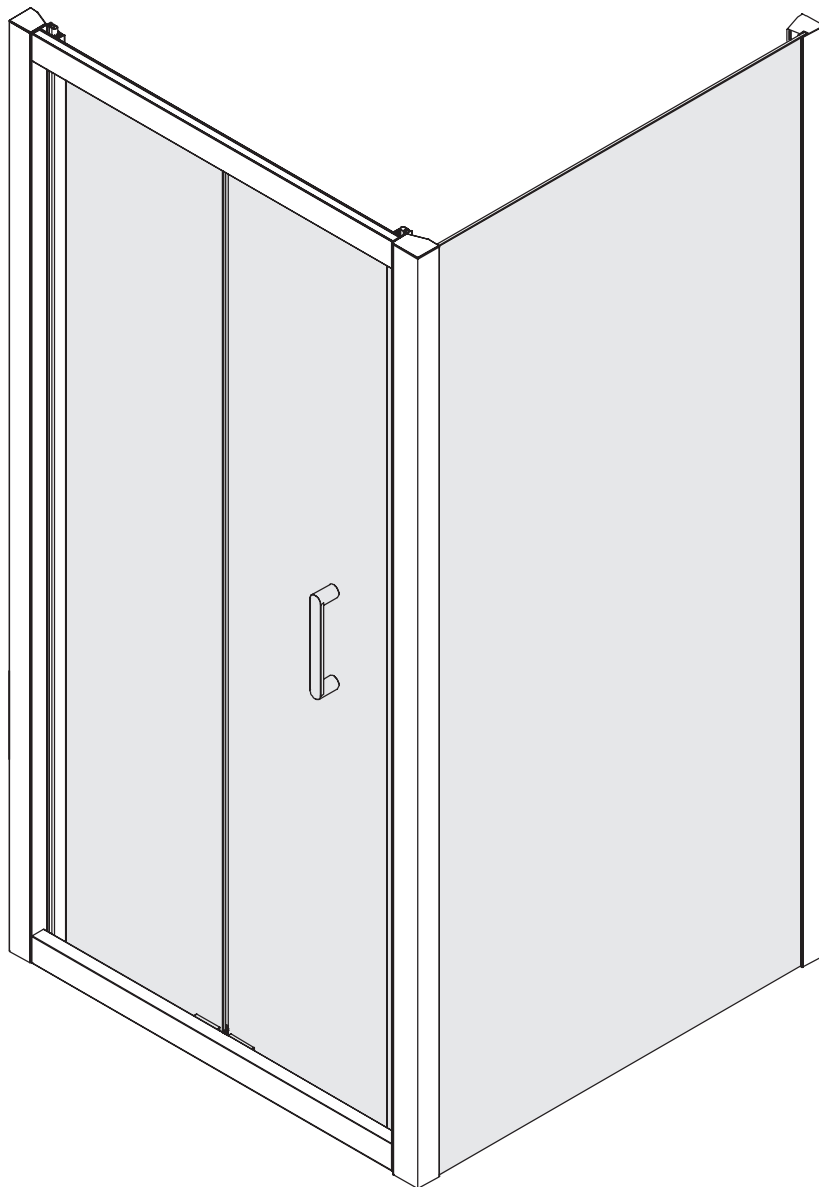

CR14

1.

### CR-14

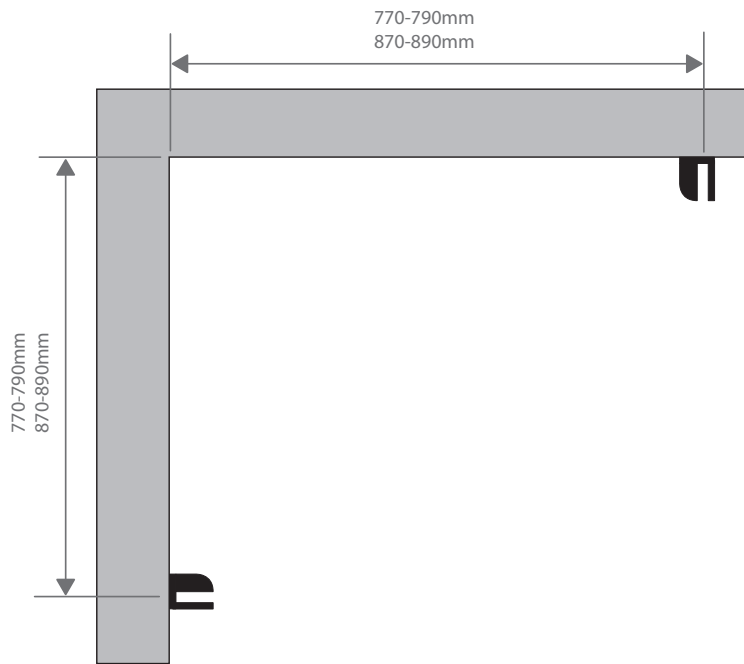

#### additional tools

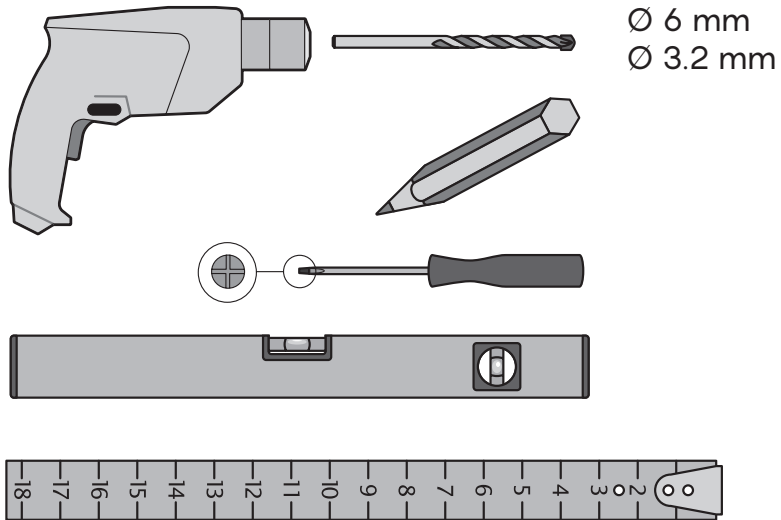
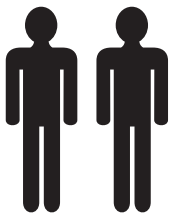

#### included

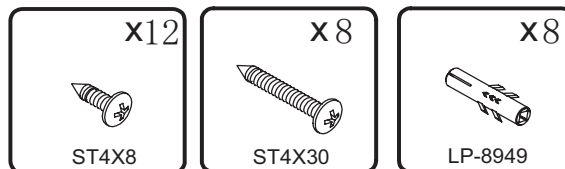

2.



**NL** Lees deze instructies aandachtig voordat u aan de installatie begint.  
**GB** Read instructions carefully before installing this product.  
**FR** Veuillez lire les instructions attentivement avant d'installer le produit.  
**DE** Bitte beachten Sie die Vorschriften sorgfältig bevor Sie mit der Installation anfangen.

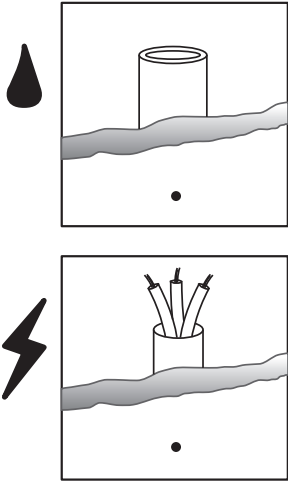

**NL** Verzeker u dat er bij de boorplaatsen geen leidingen of elektrische draden in de muur zitten.  
**GB** Always be aware of hidden pipes and wires when drilling into walls and floors.  
**FR** Avant de percer, s'assurer qu'il n'y a pas de tuyaux ou fils électrique caché dans le mur.  
**DE** Bitte prüfen Sie ob sich an den Bohrstellen keine Leitungen oder elektrische Kabel befinden.

3.

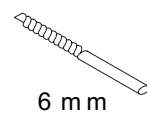
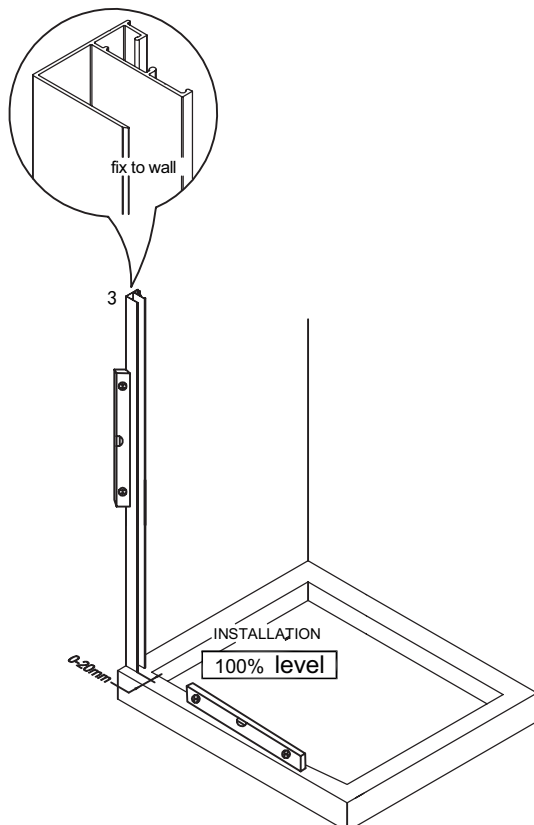

6 mm



X 4

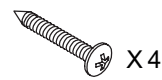

X 4  
ST 4 X 30

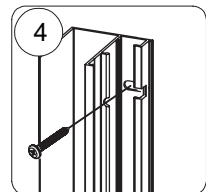
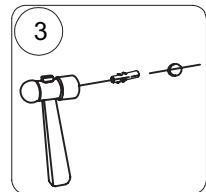
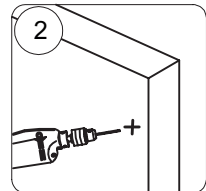
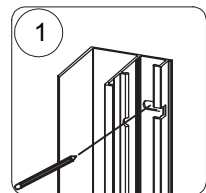

4.

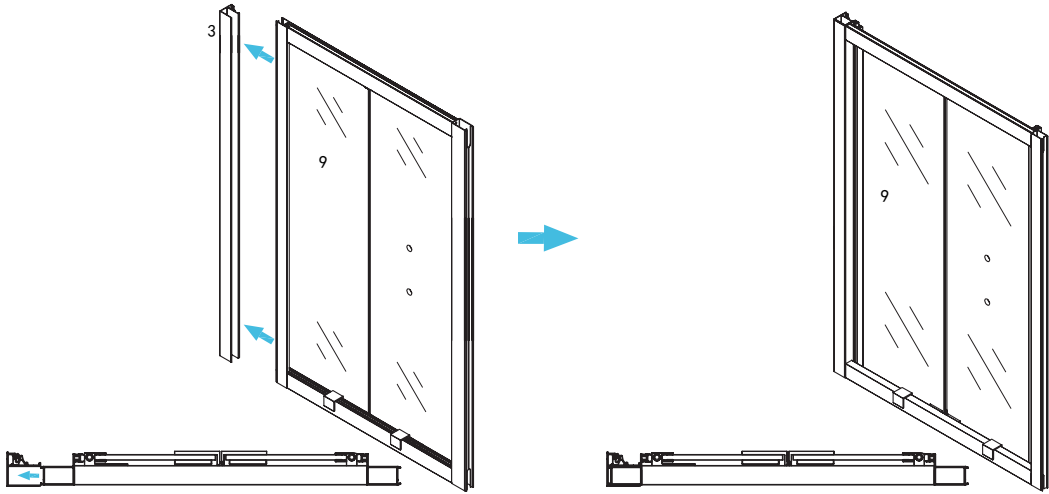

5.

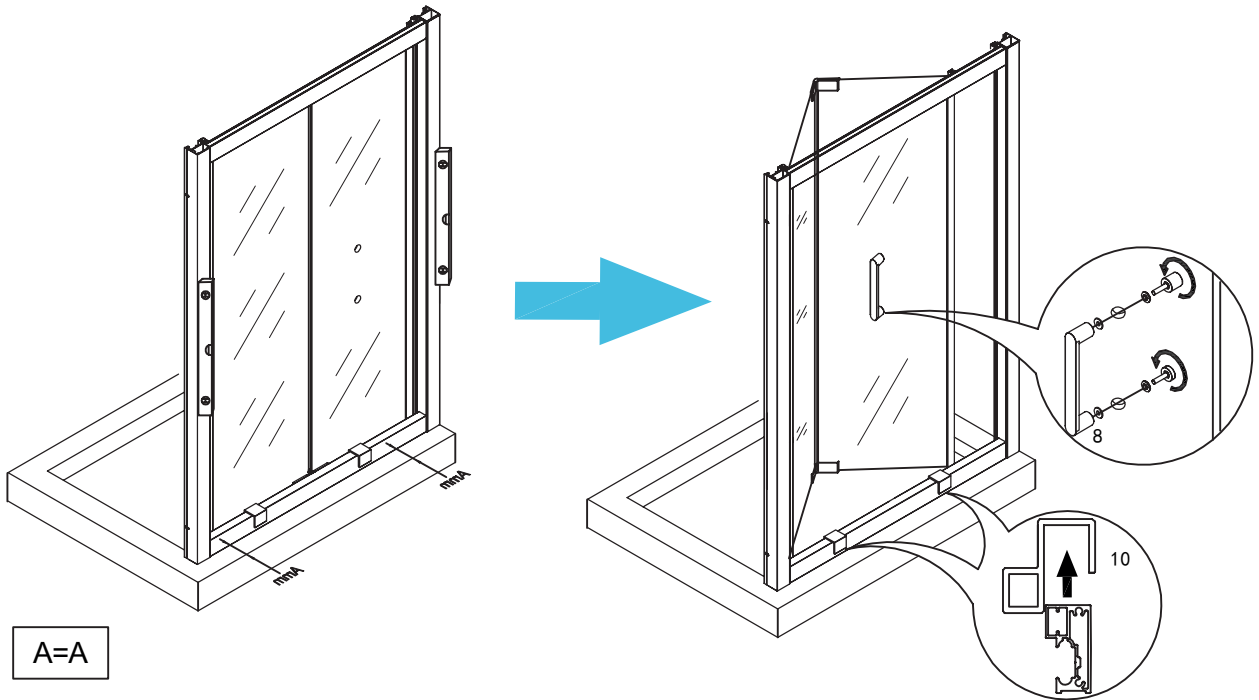

6.

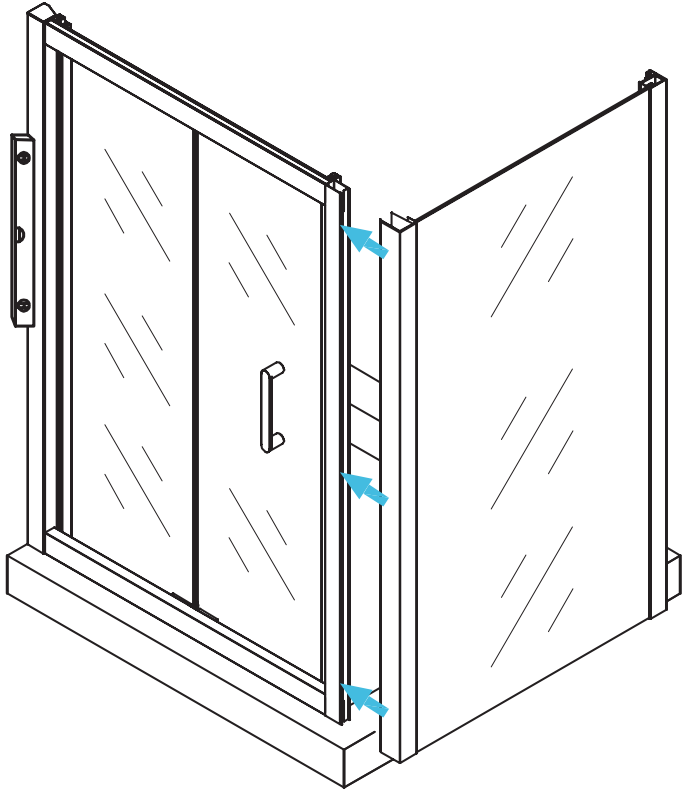

7.

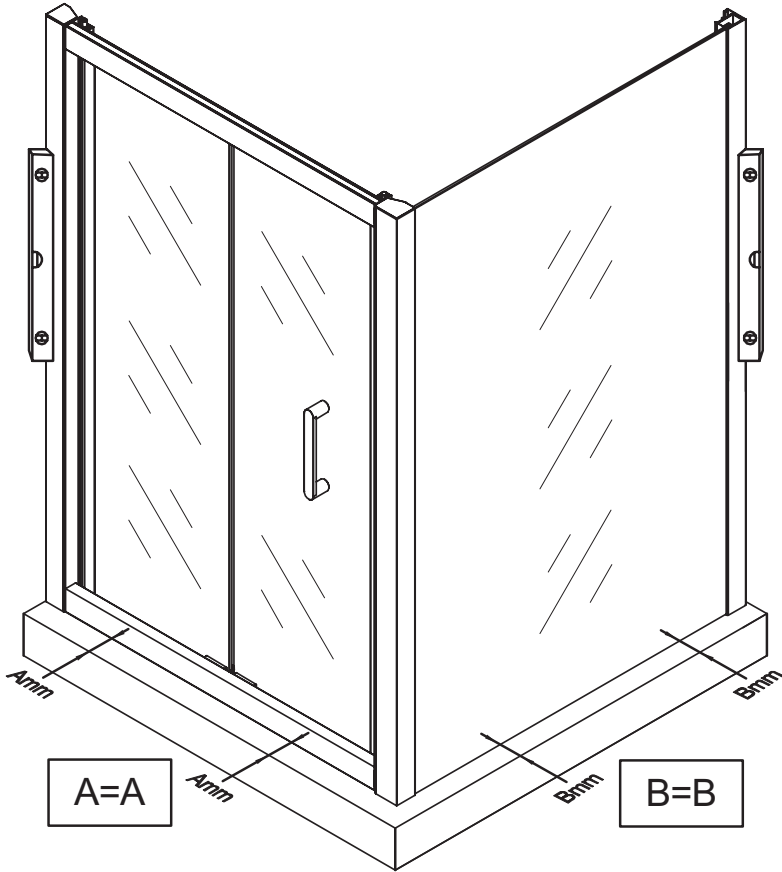

8.

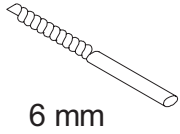
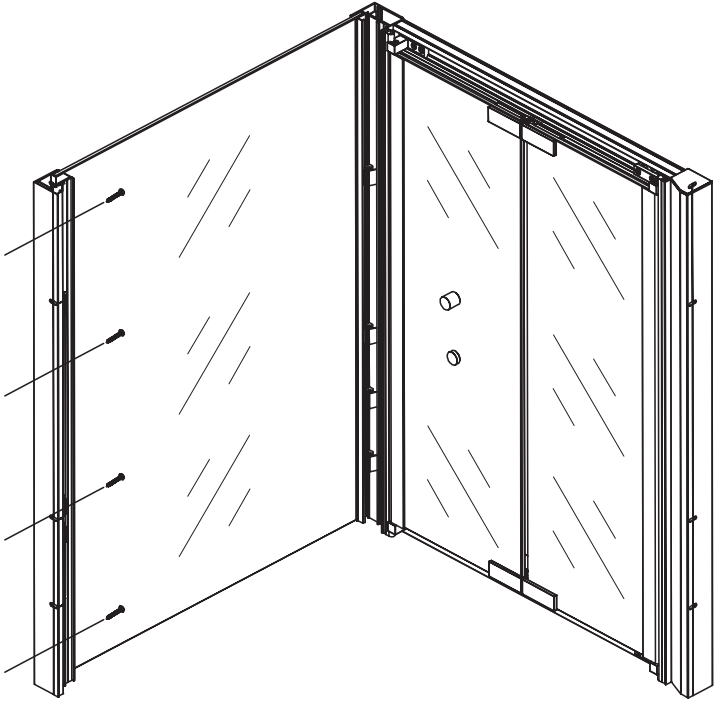

6 mm



X4

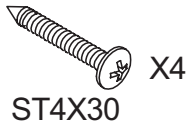

X4

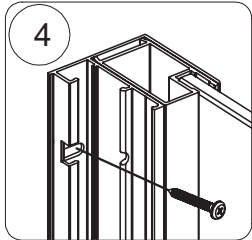
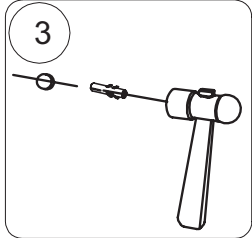
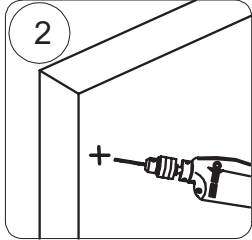
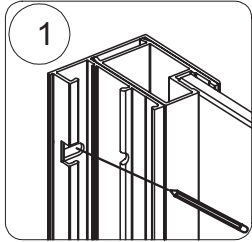

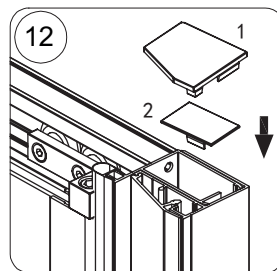
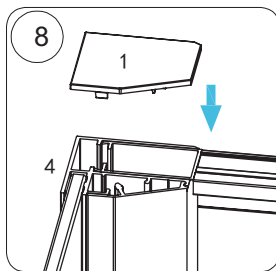
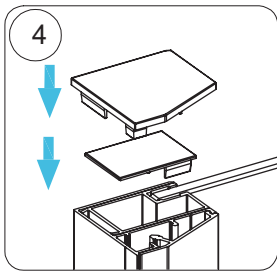
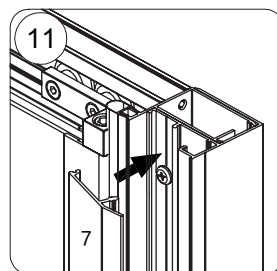
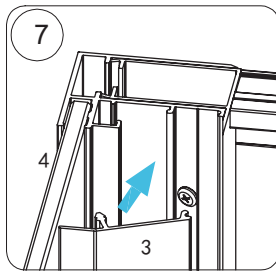
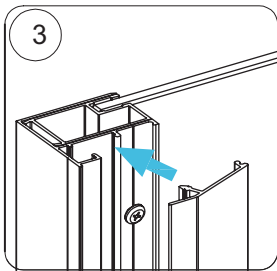
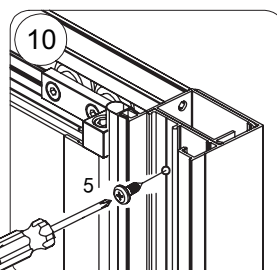
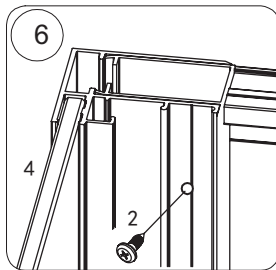
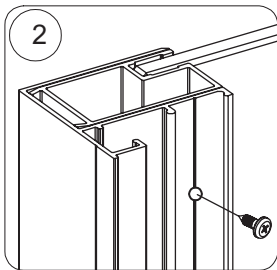
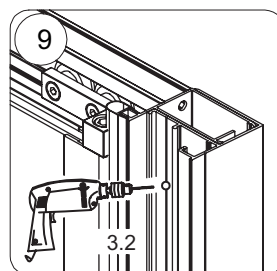
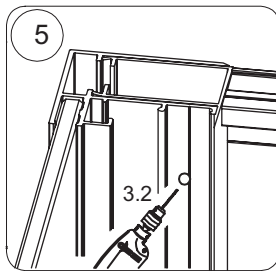
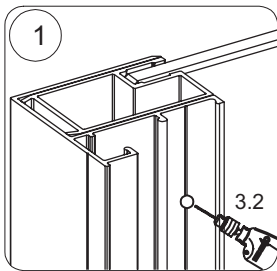
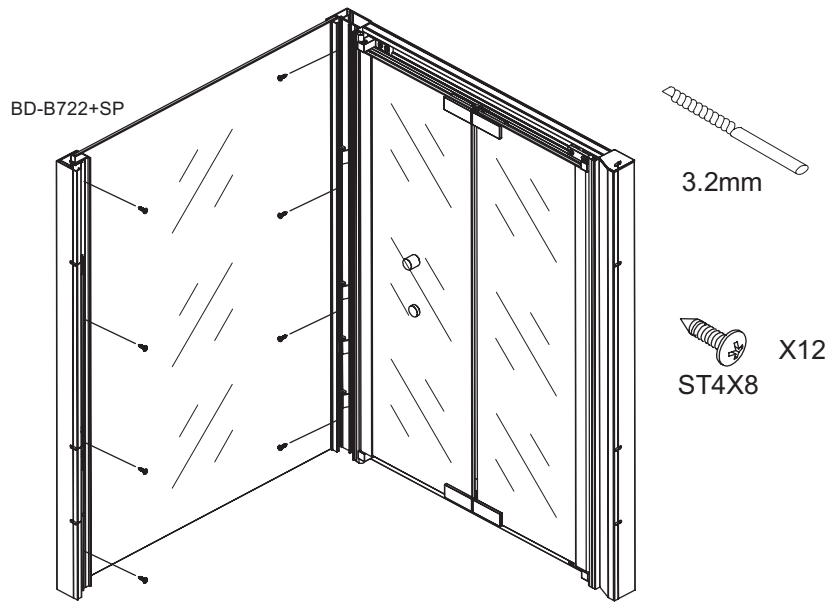

10.

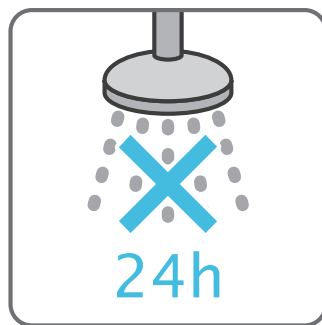
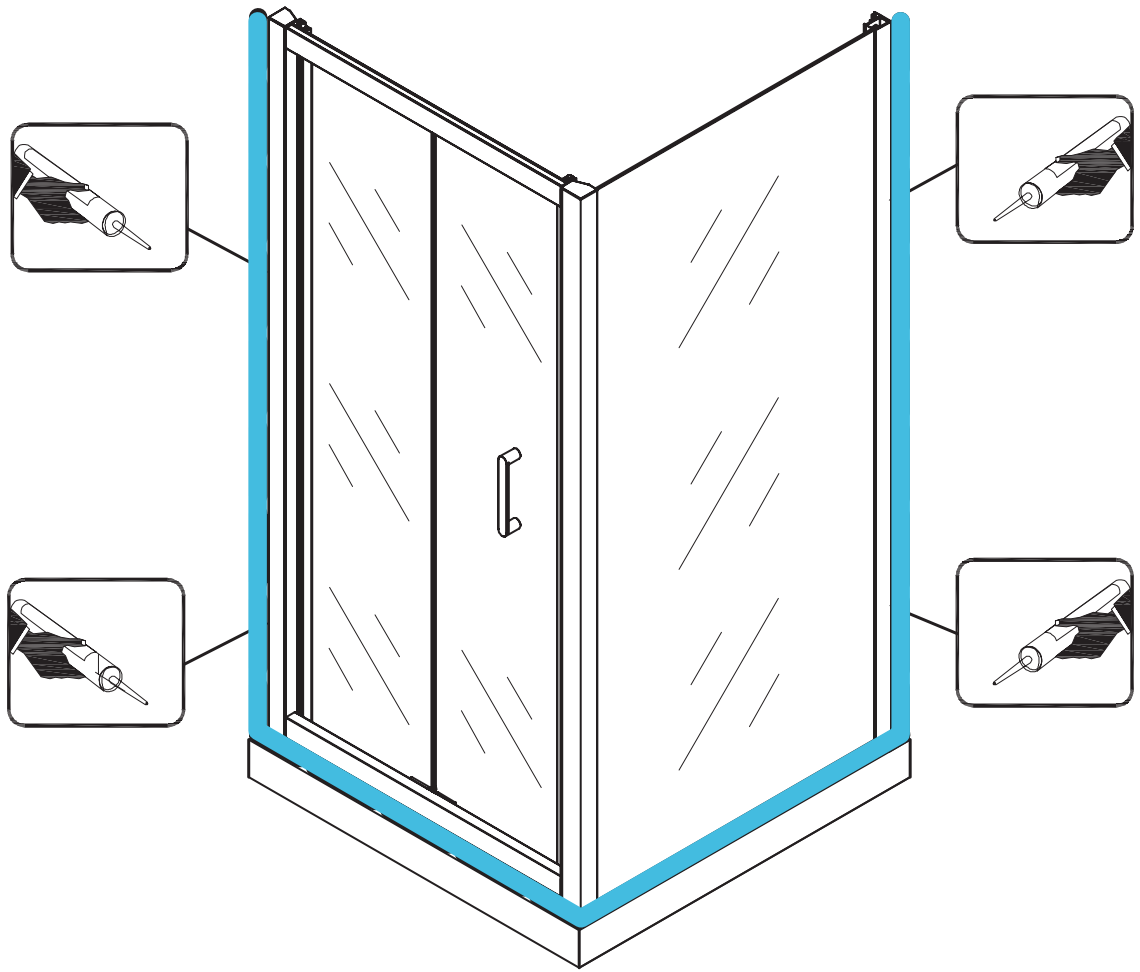



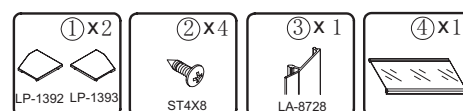
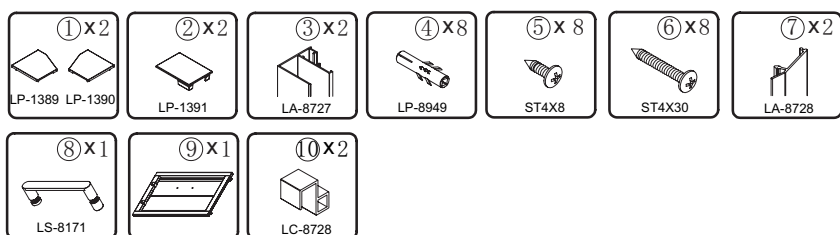
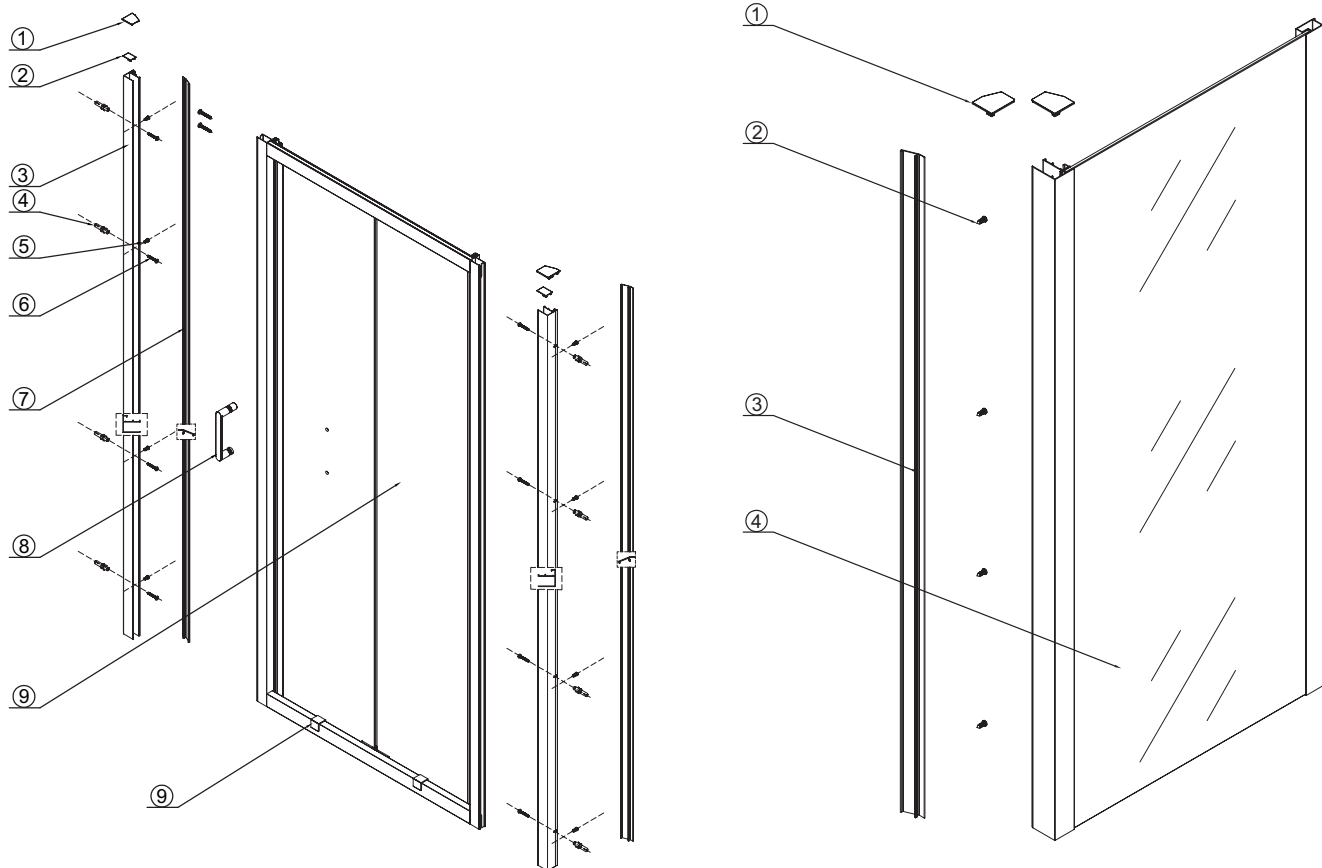

**NL** Voor de reiniging dient u een PH neutraal reinigingsmiddel of de aanbevolen Sealskin douchereiniger te gebruiken. Geen verdunner, alkalische, zuur, chloor of schurende middelen gebruiken.

**GB** For cleaning use a pH-neutral cleaning agent or the special cleaner recommended by us. Not to use are solvents, as well as alkaline, solvent -, acid- and chloric or scrubbing agents.

**FR** Pour nettoyer veuillez utiliser s'il vous plaît un produit de nettoyage avec PH neutre ou le produit spéciale recommandé par nous. N'utilisez pas des solvants, ainsi qu'alcalins, acides ou produits avec du chlore ou agressif.

**DE** Zur Reinigung benutzen Sie ein PH-neutrales Reinigungsmittel oder den von uns empfohlenen Spezialreiniger. Verwenden Sie keine scheuernden, alkalischen, säure- oder chlorhaltigen Reinigungsmittel sowie Oxidations- und Lösungsmittel.

**PL** Do mycia i pielęgnacji proszę używać środków czyszczących o odczynie PH obojętnym lub polecany przez nas specjalny preparat. Nie należy stosować rozpuszczalników, jak również preparatów alkalicznych, kwaśnych, zawierających chlor lub posiadających w aściwości ściernie.

**sealskin** 

Nr. VLS.16.002

Prestatieverklaring (DOP)  
 Declaration Of Performance (DOP)  
 Leistungserklärung (DOP)  
 Déclaration de Performance (DOP)  
 Declaración de Prestaciones (DOP)  
 Deklaracja właściwości użytkowych (DOP)



1. Product types: / Produkttypen: / Produit type: / Producto tipo: / Producttype: / Typu wyrobu:

GetWet Compact CR-12, CR-14, CR-16, CR-18, CR-20, CR-50, CR-60

2. Personal hygiene (PH) / Persönliche Hygiene (PH) / L'hygiène personnelle (PH) / Higiene personal (PH) / Persoonlijke hygiëne (PH) / Higiëna osobista (PH) /

3. **Sealskin B.V.**  
 Tuinstraat 26  
 5144 NT Waalwijk  
 Postbus 6, 5140 AA Waalwijk  
 Nederland

4. n.a.

5. System 4 / System 4 / Système 4 / Sistema 4 / Systeem 4 / System 4 /

6. Determination of product type and factory production control by the manufacturer  
 Feststellung des Produkttyps und werkseigene Produktionskontrolle durch den Hersteller  
 Détermination du produit type et contrôle de la production effectuée par le fabricant  
 Determinación del producto tipo y control de la producción en fábrica efectuada por el fabricante  
 De bepaling van het producttype en de productiecontrole in de fabriek wordt door de fabrikant uitgevoerd  
 Producent przeprowadza: ustalenie typu wyrobu i zakładową kontrolę produkcji

7. n.a.

8. Essential characteristics Wesentliche Merkmale Caractéristiques essentielles Características esenciales Essentiële kenmerken Zasadnicze charakterystyki	Performance Leistung Performances Prestaciones Prestaties Właściwości	Harmonized technical specification Harmonisierte technische Spezifikation Spécifications techniques harmonisées Especificaciones técnicas armonizadas Geharmoniseerde techinsche specificaties Zharmonizowana specyfikacja techniczna
CA	Pass	EN 14428:2004+A1:2008
IR	Pass	
DA	Pass	

9. The performance of the product identified in points 1 and 2 is in conformity with the declared performance in point 9. This declaration of performance is issued under the sole responsibility of the manufacturer identified in point 4. Signed for and on behalf of the manufacturer by:

Die Leistung des Produkts gemäß den Nummern 1 und 2 entspricht der erklärten Leistung nach Nummer 9. Verantwortlich für die Erstellung dieser Leistungserklärung ist allein der Hersteller gemäß Nummer 4. Unterzeichnet für den Hersteller und im Namen des Herstellers von:  
 Les performances du produit identifié aux points 1 et 2 sont conformes aux performances déclarées indiquées au point 9. La présente déclaration des performances est établie sous la seule responsabilité du fabricant identifié au point 4. Signé pour le fabricant et en son nom par:  
 Las prestaciones del producto identificado en los puntos 1 y 2 son conformes con las prestaciones declaradas en el punto 9. La presente declaración de prestaciones se emite bajo la sola responsabilidad del fabricante identificado en el punto 4. Firmado por y en nombre del fabricante por:  
 De prestaties van het in de punten 1 en 2 omschreven product zijn conform de in punt 9 aangegeven prestaties. Deze prestatieverklaring wordt verstrekt onder de exclusieve verantwoordelijkheid van de in punt 4 vermelde fabrikant:  
 Ondertekend voor en namens de fabrikant door:  
 Właściwości użytkowe wyrobu określone w pkt 1 i 2 są zgodne z właściwościami użytkowymi deklarowanymi w pkt 9.  
 Niniejsza deklaracja właściwości

J. Elsen

Legal representative / Gesetzlicher Vertreter / Représentant légal /  
 Representante legal / Wettelijke vertegenwoordiger / Przedstawiciele prawnych

Waalwijk, 4-4-2016

# compact

Garantiebewijs  
Warranty card  
Garantieschein  
Carte de garantie  
Certificato di garanzia  
Certificado de garantia

**CR14**

This Sealskin Get Wet product has a warranty period of 5 years. Normal wear and tear on components such as transparent gaskets are excluded from this warranty.

Wholesale dealer: .....

Address: .....

Phone: .....

Fax: .....

Installer: .....

Address: .....

Phone: .....

Fax: .....

NL De producent houdt zich het recht voor, ten alle tijde zonder tegenbericht, veranderingen door te voeren.  
GB The producer reserves the right to modify the product at any time without prior notice.  
DE Der Produzent behält sich jederzeit das Recht, ohne Vorbescheid Abänderungen vorzunehmen.  
FR Le producteur se réserve le droit de modifier le produit sans aucun préavis.  
SV Tillverkaren förbehåller sig all rätt att produktförändra  
PL Producent rezerwuje sobie prawo modyfikacji produktu bez wczesniejszego powiadomienia.