

*Helmond IMP*  
Art. Nr. 2845150  
1/7

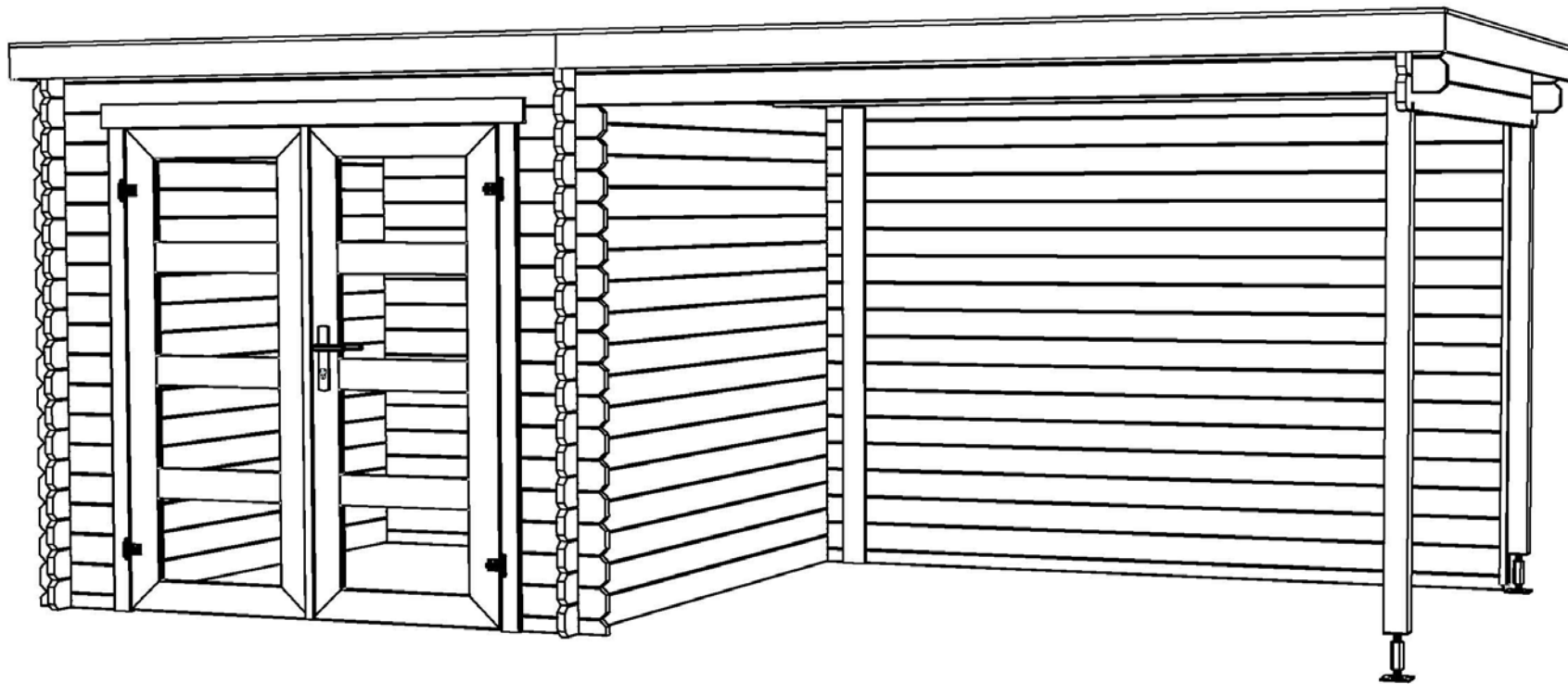

Art. Nr. 2845150

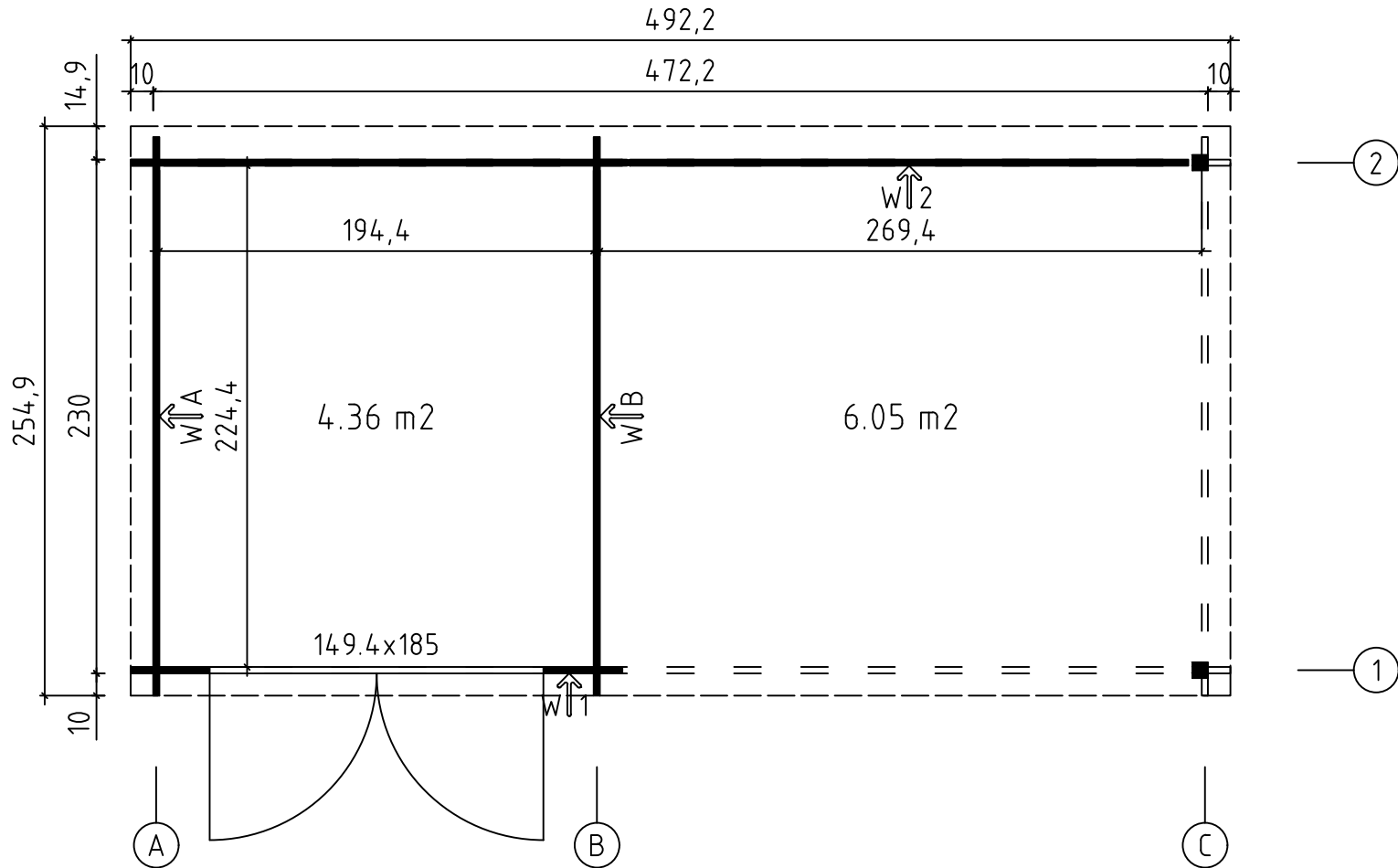



Groundplan - Grundplan - Plan de masse - Planimetria -  
Plattegrond - Põhiplaan



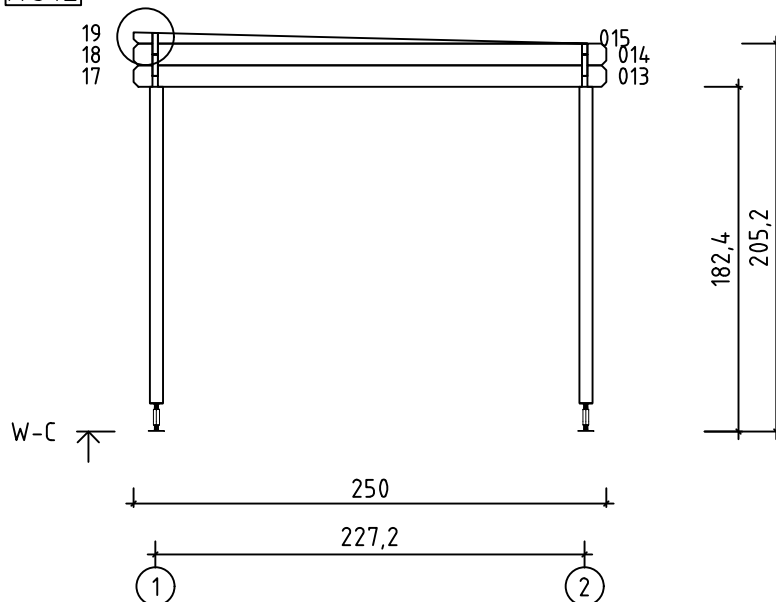
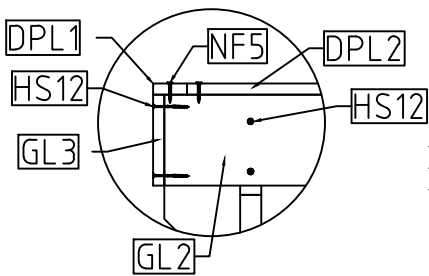
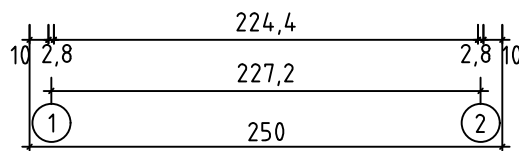
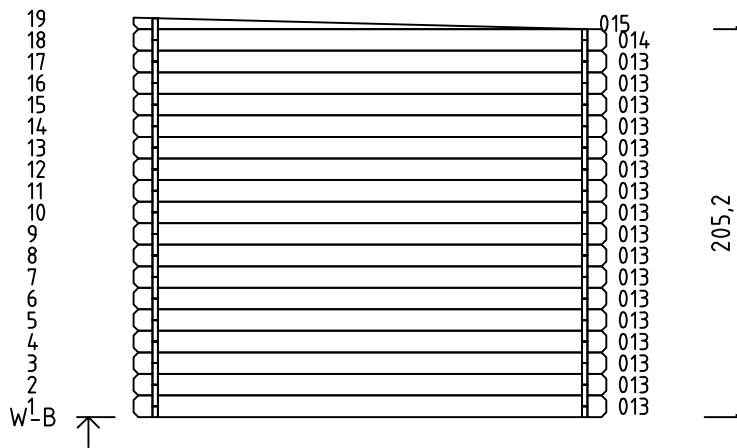
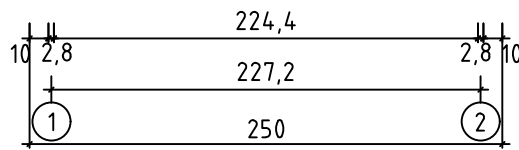
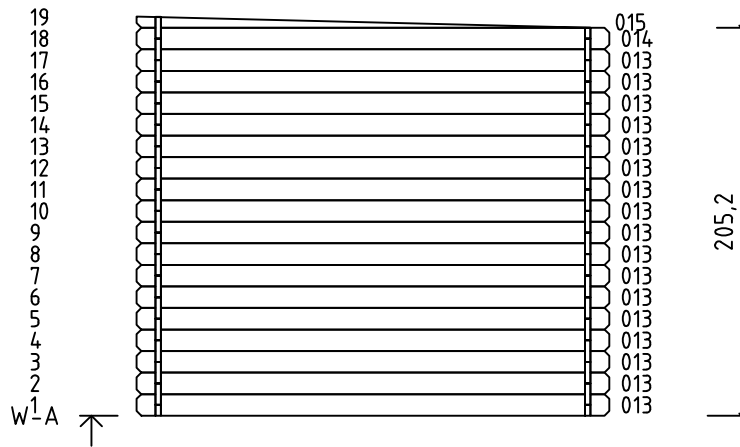



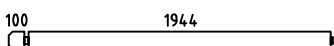
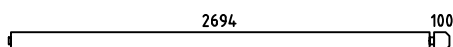
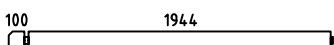
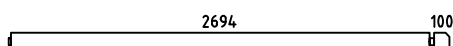
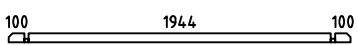
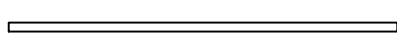
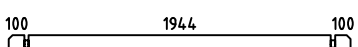
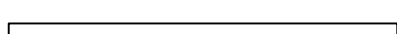
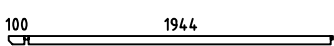
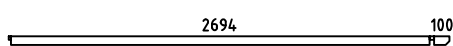
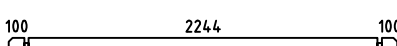
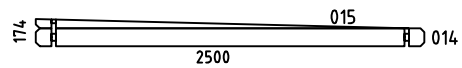
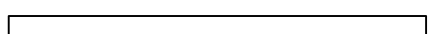
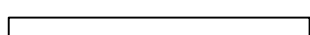
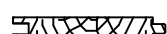
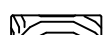
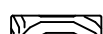

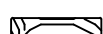

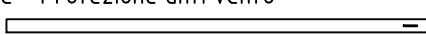

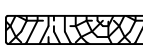
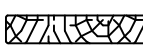
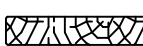

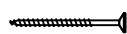
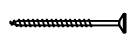

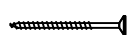
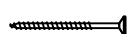

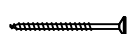
Art. Nr. 2845150

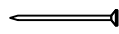
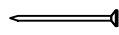

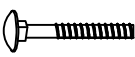
| Pos                  | 26.09.2018 Piece list - Stückliste - Liste des pièces - Elementi - Stuklijst - Tükítabel<br>Art. Nr. 2845150 5/7   | Q           | P<br>(mm) | L<br>(mm) |
|----------------------|--|-------------|-----------|-----------|
| 001                  |  100 220  | 2           | 28x57     | 348       |
| 002                  |  100 220  | 32          | 28x114    | 348       |
| 003                  |  100 1944   | 2           | 28x114    | 2086      |
| 004                  |  2694 100   | 2           | 28x114    | 2836      |
| 005                  |  100 1944   | 1           | 28x114    | 2086      |
| 006                  |  2694 100   | 1           | 28x114    | 2836      |
| 007                  |  100 1944 100   | 1           | 28x57     | 2200      |
| 008                  |   | 1           | 28x57     | 2500      |
| 009                  |  100 1944 100   | 16          | 28x114    | 2200      |
| 010                  |   | 16          | 28x114    | 2500      |
| 011                  |  100 1944   | 1           | 28x55     | 2086      |
| 012                  |  2694 100   | 1           | 28x55     | 2836      |
| 013                  |  100 2244 100   | 35          | 28x114    | 2500      |
| WA-1<br>WB-1<br>WC-1 |  174 2500 015 014  | 1<br>1<br>1 |           |           |
| A-PR2                | Roof beam - Dachbalken - Panne de toit - Perlina del tetto - Gordingen / dakbalk - Pärilin<br>  | 3           | 44x140    | 2686      |
| A-PR1                | Roof beam - Dachbalken - Panne de toit - Perlina del tetto - Gordingen / dakbalk - Pärilin<br>  | 3           | 44x140    | 1936      |
|                      | Roof boards - Dachbretter - Voliges - Perlina per tetto - Dakhout - Katuselaud<br>  | 55          | 90x15     | 2550      |
| DPL1                 | Roofing felt fillet - Dachpappenleiste - Baguette de fixation du feutre bitumeux - Asse per fissaggio guaina bituminosa - Afdeklijst asfaltpapier - Katusepapiilist<br> | 2           | 15x45     | 2476      |
| DPL2                 | Roofing felt fillet - Dachpappenleiste - Baguette de fixation du feutre bitumeux - Asse per fissaggio guaina bituminosa - Afdeklijst asfaltpapier - Katusepapiilist<br> | 2           | 15x45     | 2570      |
| DPP-1                | Roofing felt (strip) - Dachpappe (bahnen) - Feutre bitumeux (bande) - Cartone catramato - Asfaltpapier (baan) - Katusepapp<br>  | 3           |           | 5000      |
| P                    | Post - Pfosten - Poteau - Piede registrabile - Stijl - Post<br>  | 2           | 70x70     | 1782      |
| DRV-1                | Roof edge reinforcement - Dachrandverstärkung - Corniere de renfort de bord de toit - Rinforzo x tetto - Dakrand versterking - Räästatugevdus<br>                       | 2           | 15x45     | 2461      |

| Pos   | 26.09.2018 Piece list - Stückliste - Liste des pièces - Elementi - Stuklijst - Tükítabel<br>Art. Nr. 2845150 6/7  | Q   | P<br>(mm) | L<br>(mm) |
|-------|---|-----|-----------|-----------|
| HP    | H-profile - H-profils - Profile H - Profilo ad H - H-profiel - H-profiil   | 1   | 58x90     | 1935      |
| KFS-1 | Storm protection - Sturmleiste - Latte anti-tempete - Protezione anti vento - Stormverankering / beveiliging - Tormikinnusliist   | 4   | 22x45     | 2050      |
| KFS-2 | U-profile - U-profils - Profile u - Profilo ad u - U-profiel - U-profiil   | 1   | 28x58     | 1850      |
| GL1   | Gable moulding - Giebelleiste - Planche de rive - Finitura per frontale e retro del tetto - Gevellijst - Viilulaud   | 1   | 15x120    | 2101      |
| GL2   | Gable moulding - Giebelleiste - Planche de rive - Finitura per frontale e retro del tetto - Gevellijst - Viilulaud   | 2   | 15x120    | 2600      |
| GL3   | Gable moulding - Giebelleiste - Planche de rive - Finitura per frontale e retro del tetto - Gevellijst - Viilulaud   | 1   | 15x120    | 2851      |
| HS9   | Screw for u-profile - Schraube zur befestigung u-profils - Vis a tete fraisée pour profil u - Vite per profilo ad u - Schroef ter bevestiging u-profiel - Kruvi U-profiilile   | 3   | 3.5x50    |           |
| HS4   | Screw for roof edge reinforcement - Schrauben für dachrandverstärkung - Vis pour fixation corniere renfort de bord de toit - Viti x rinforzo bordo tetto - Schroef voor dakrand versterking - Kruvi räästatugevdusele    | 12  | 3x30      |           |
| HS11  | Screw for beam holder - Schrauben für balkenhalter - Vis de fixation support "u" galvanisé - Vite per trave di sostegno - Schroef voor bevestiging balkhouder (gordingschoen) - Kruvi talakingale    | 144 | 4x30      |           |
| HS12  | Screw for gable moulding - Schrauben für giebelleiste - Vis pour fixation planche de rive - Vite per fissare finiture davanti e dietro del tetto - Schroef voor gevellijst - Kruvi viilulauale   | 20  | 4x40      |           |
| HS13  | Screw for h-profile - Schraube zur befestigung h-profils - Vis a tete fraisée pour profil h - Vite per profilo ad h - Schroef ter bevestiging h-profiel - Kruvi H-profiilile   | 1   | 4x60      |           |
| HS13  | Screw for post - Schrauben für pfosten - Vis de fixation des poteaux - Viti per inviare - Schroef voor stijlen - Kruvi postile   | 4   | 4x60      |           |
| HS18  | Screw for wall details - Schraube für wand details - Vis pour mur details - Viti per elementi della porta - Schroef voor wand details - Kruvi seinadetailidele   | 8   | 5x120     |           |
| HS18  | Screw for gable - Schrauben für giebel - Vis pour fixation des pignons - Viti per timpano - Schroef voor gevelpunt - Kruvi viilude kinnitamiseks   | 6   | 5x120     |           |
| HS20  | Screw for post height adjustment - Schrauben für regulierungsschraube für pfosten - Vis de fixation de support réglable de poteau - Viti per fissare ed aggiustare l'altezza del palo verticale - Schroef voor hoogte instelling stijlen - Kruvi vajumisplidile  | 16  | 6x50      |           |
| SH28  | Hammer block - Schlagholz - Calle de frappe - Blocco di legno da usare come cuscinetto quando si usa il martello - Slagklos - Löögiklots   | 1   |           |           |
| SFS   | Nut for storm protection - Schraubenmutter für sturmleiste - Erou pour latte anti-tempete - Dado x asta protezione vento - Moer voor stormverankering - Mutter tormikinnusliistule   | 8   | D6        |           |
| NF4   | Zn nail for roof - Zn nagel für dachbretter - Pointe pour fixation voliges de toit - Chiodi x perline tetto - Spijker(nagel) voor dakhout - Nael katuselauale    | 292 | 2x50      |           |
| NF5   | Zn nail for roofing felt fillet - Zn nagel für dachpappenleiste - Pointe pour baguette de fixation feutre bitumeux - Chiodi x carta bituminosa x tetto - Spijker(nagel) voor asfaltpapier afdekljst - Papiiistunael    | 26  | 2x40      |           |
| NF6   | Roofing nails for roofing felt - Nägel für dachpappe - Pointe pour fixation feutre bitumeux - Chiodi per cartone catramato - Asphalt-nagel - Papinael    | 136 | 2.8x15    |           |
| BFS   | Bolt for storm protection - Bolzen für sturmleiste - Boulon pour latte anti-tempete - Bullone x asta protezione vento - Bout voor stormankerlat - Puidupolt tormikinnusliistule    | 8   | 6x60      |           |
| DFS   | Washer for storm protection - Dichtscheibe für sturmleiste - Rondelle pour latte anti-tempete - Rondella x asta protezione vento - Afdichtring voor storm strip - Seib tormikinnusliistule   | 8   | D6        |           |
| BM    | Beam holder - Balkenhalter - Support en u galvanisé - Supporto della trave Balkendrager (gording schoen) - Talaking    | 12  | 45x137    |           |













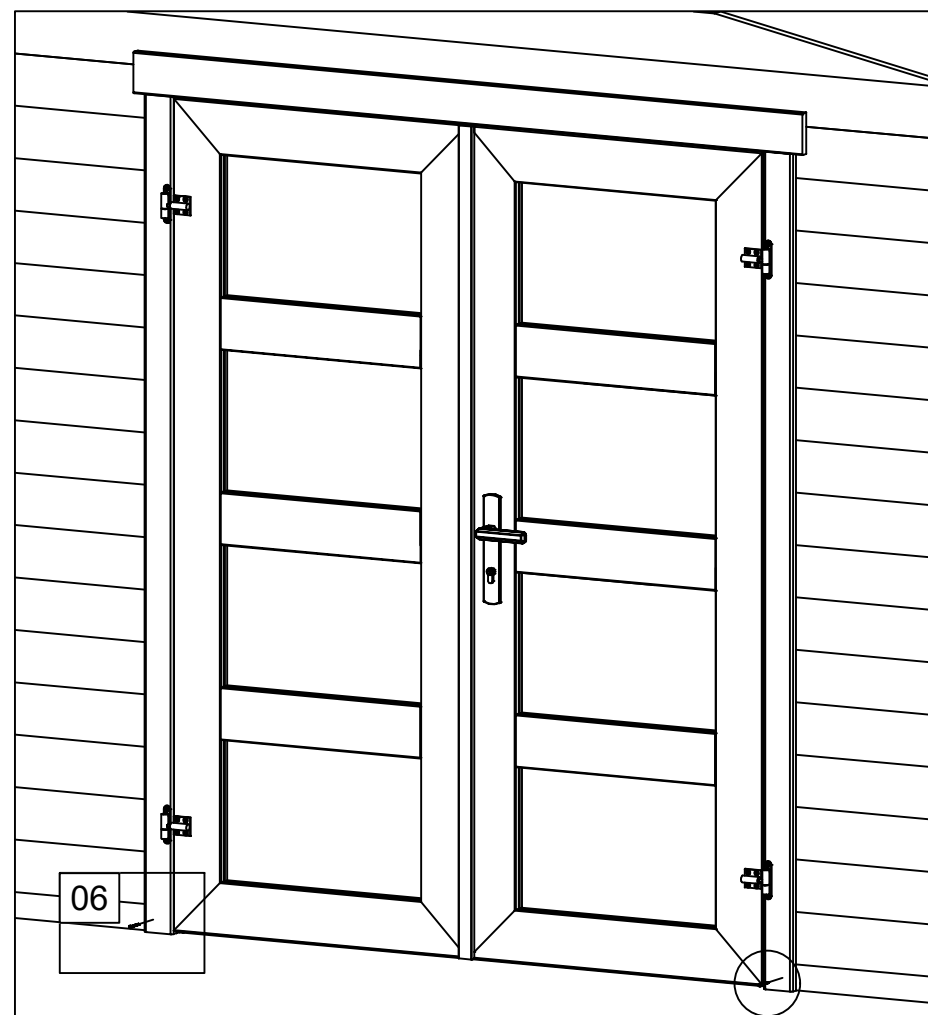
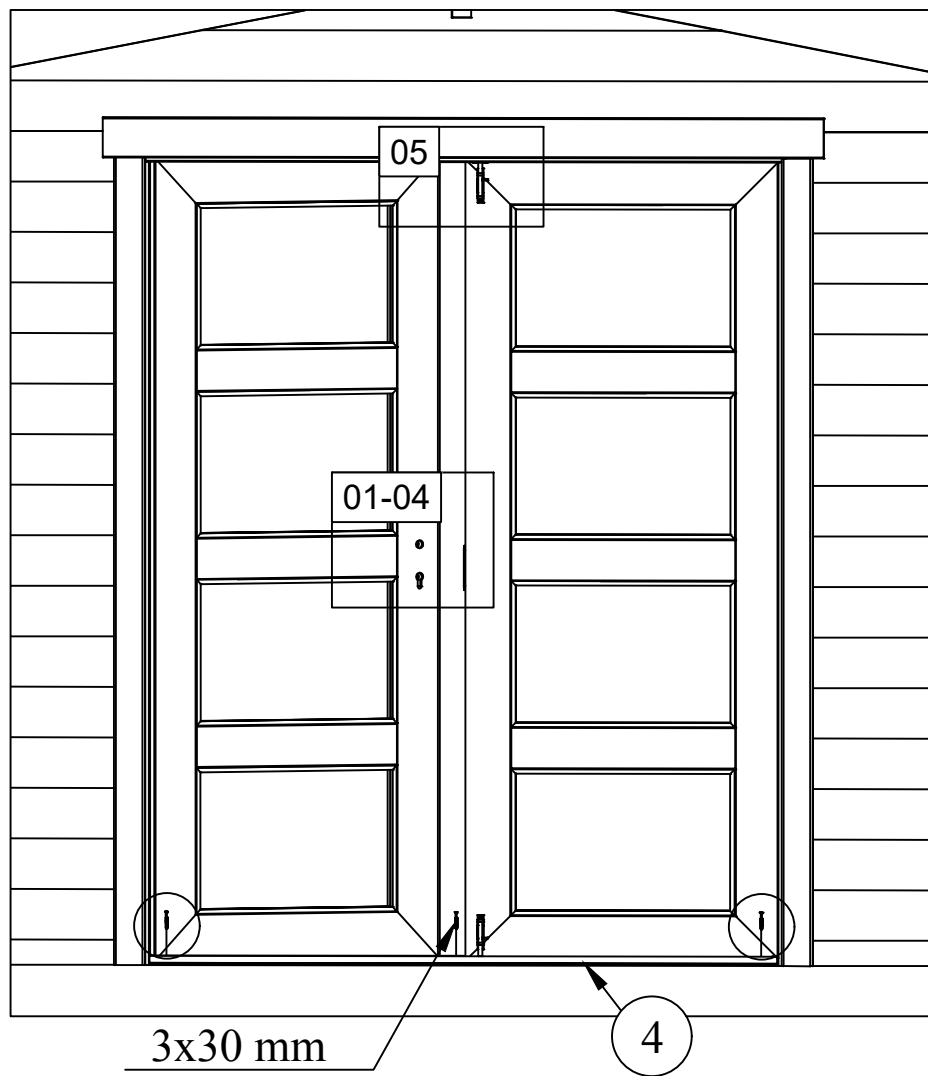

01

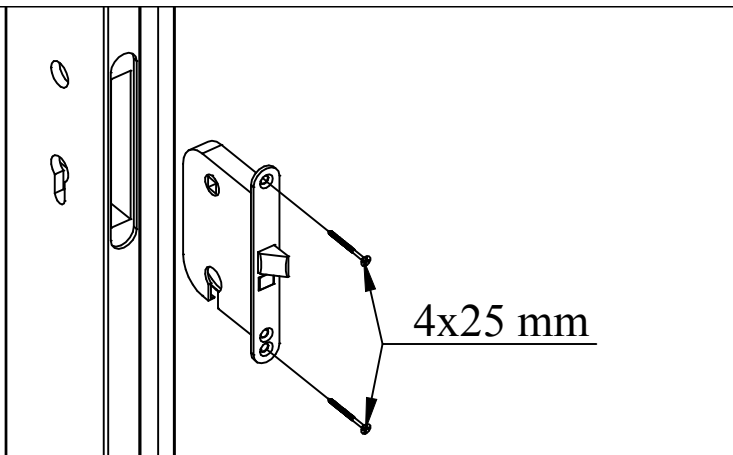

04

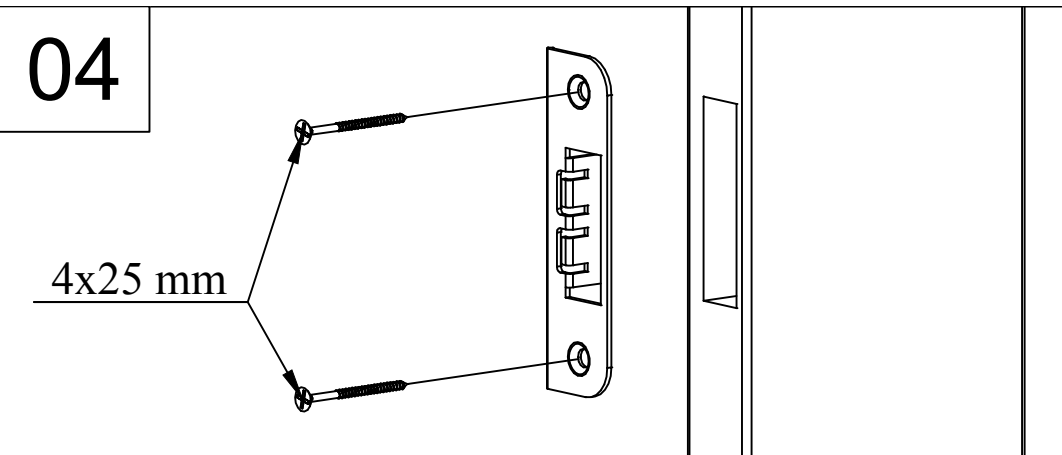

02

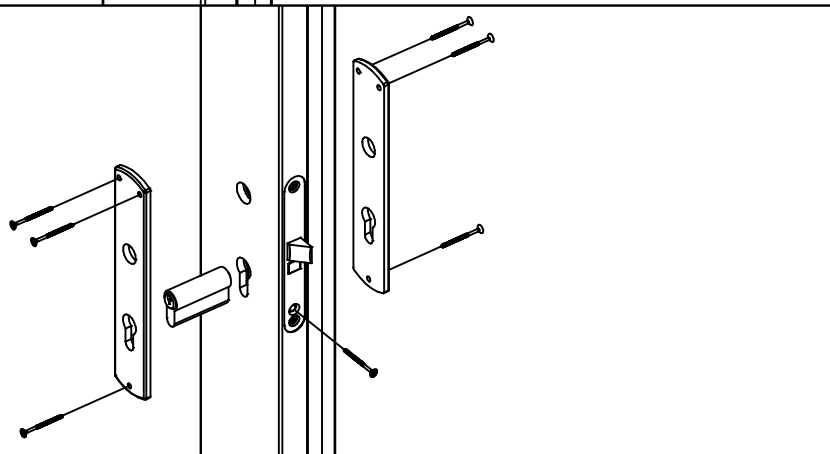

05

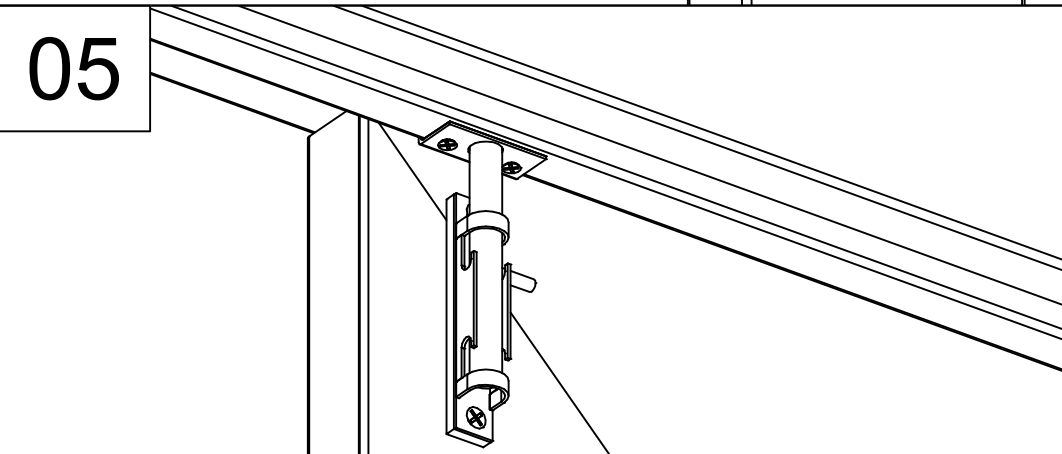

03

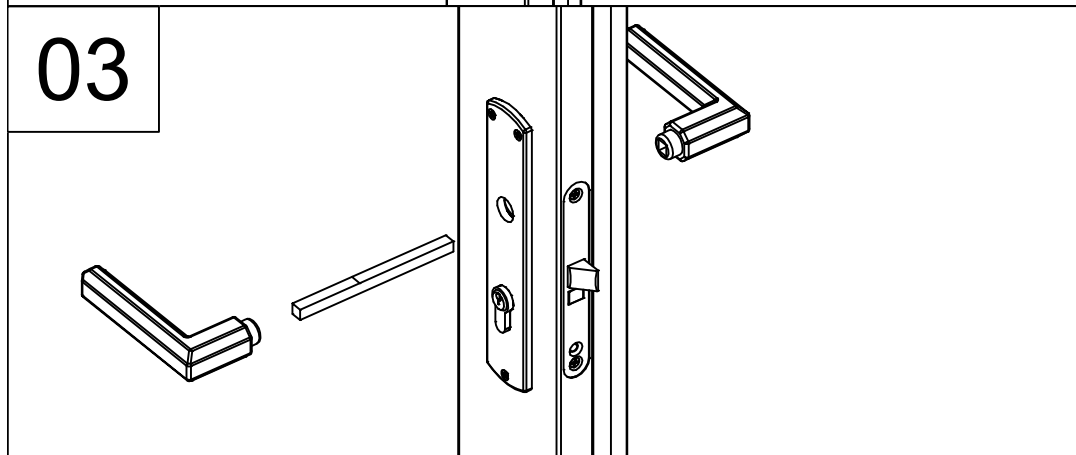

06

