

LOUNGE SOFA

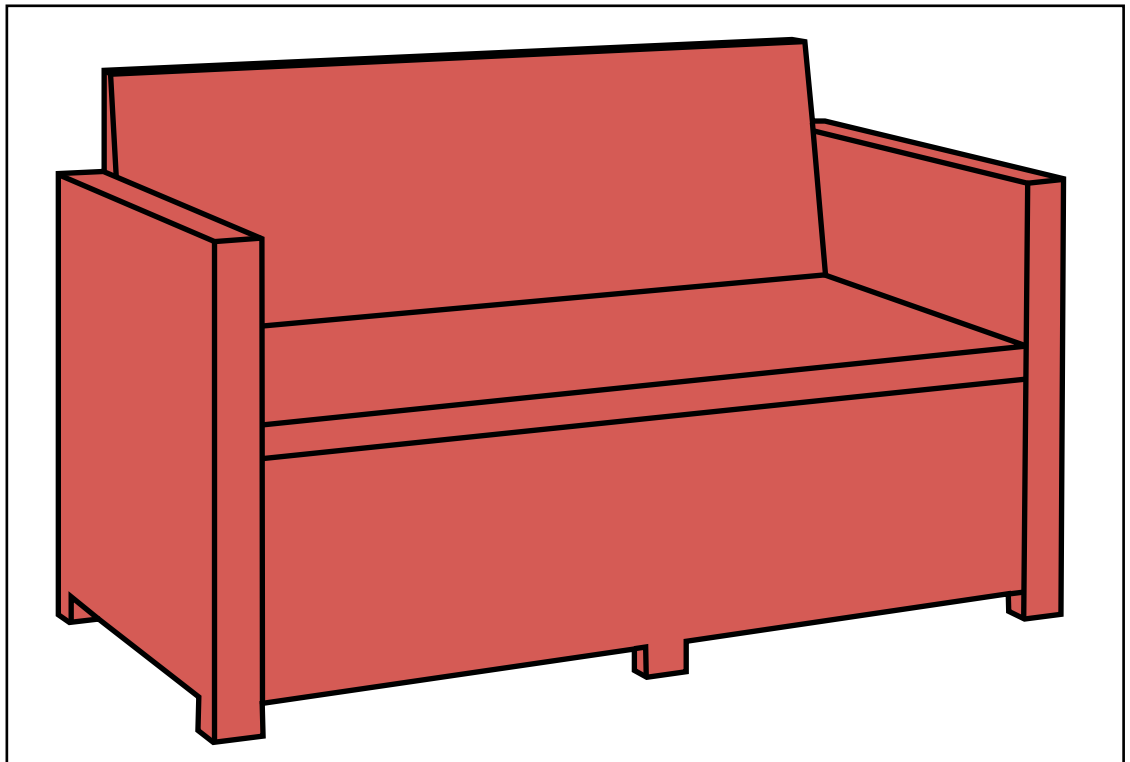

ALLiBERT 

Ericssonstraat 17 | 5121 MK RIJEN | The Netherlands | WWW.ALLIBERT-OUTDOOR.COM

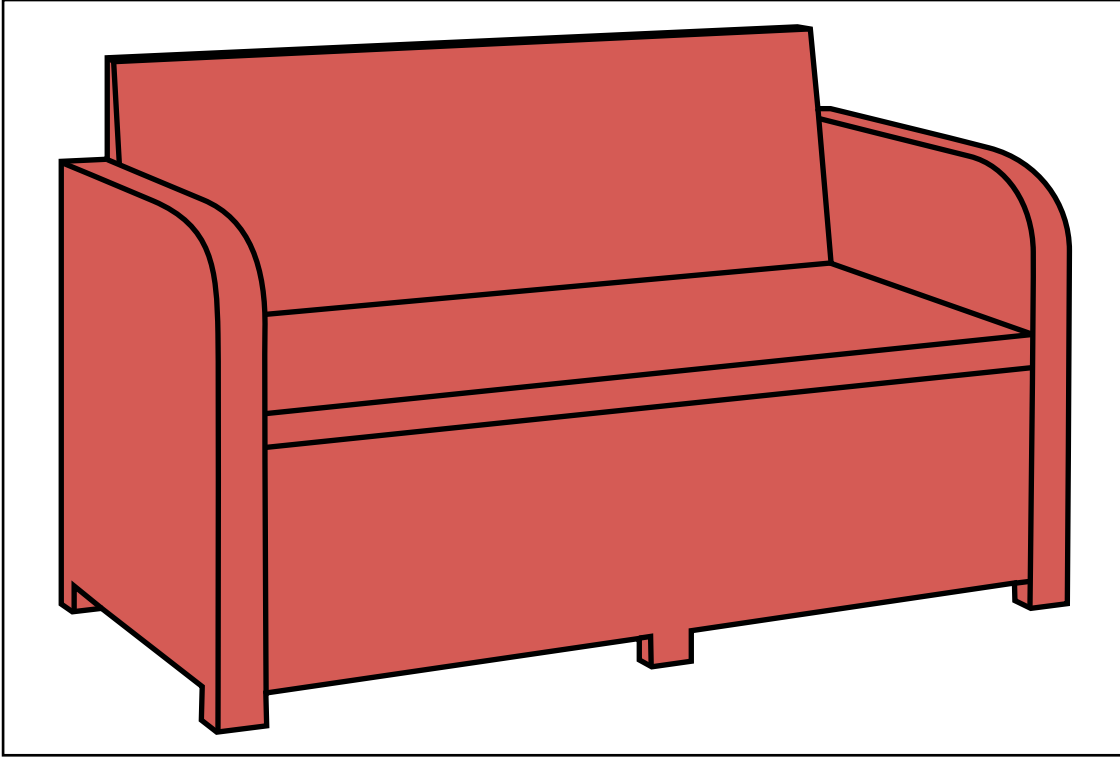

NEN 581

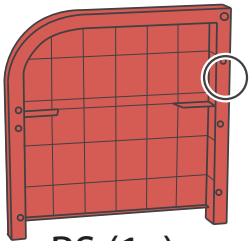
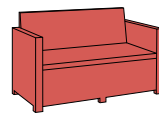
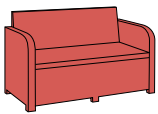

RS (1x)

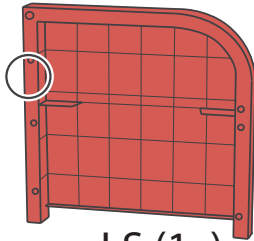

LS (1x)

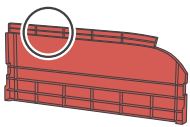

SCR (1x)

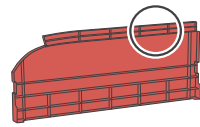

SCL (1x)

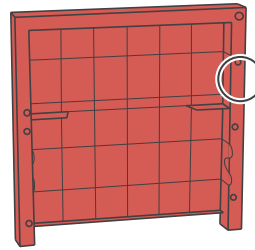

RS (1x)

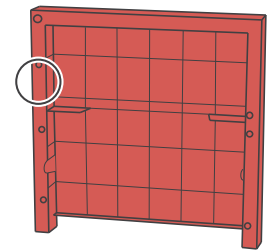

LS (1x)

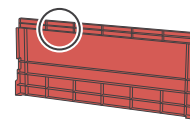

SC (2x)

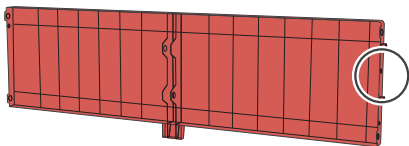

FCS1 (1x)

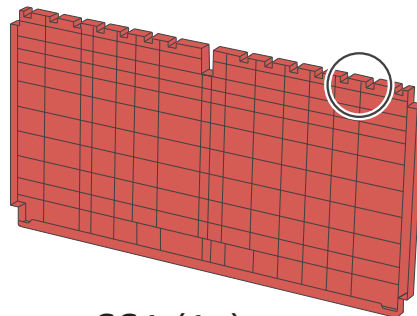

SS1 (1x)

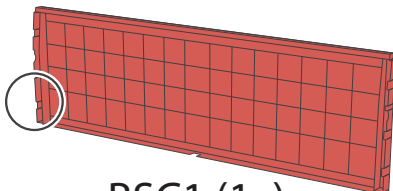

BSC1 (1x)

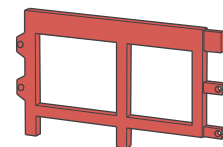

Q (1x)

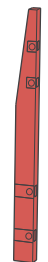

R (1x)

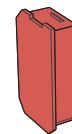

NA (2x)

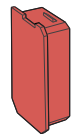

NB (2x)

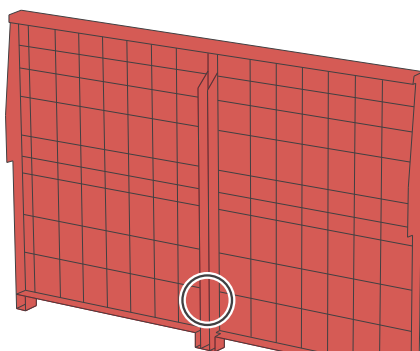

BS1 (1x)

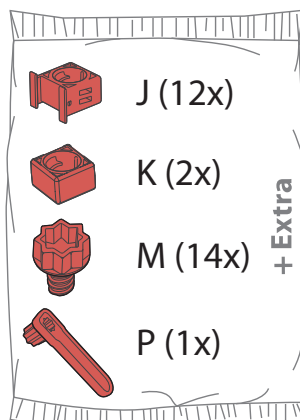

J (12x)

K (2x)

M (14x) + Extra

P (1x)

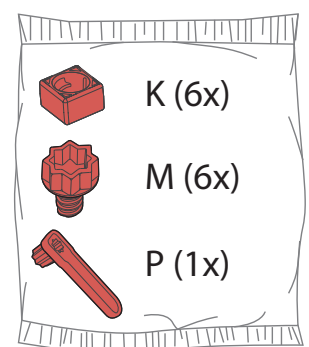

K (6x)

M (6x)

P (1x)

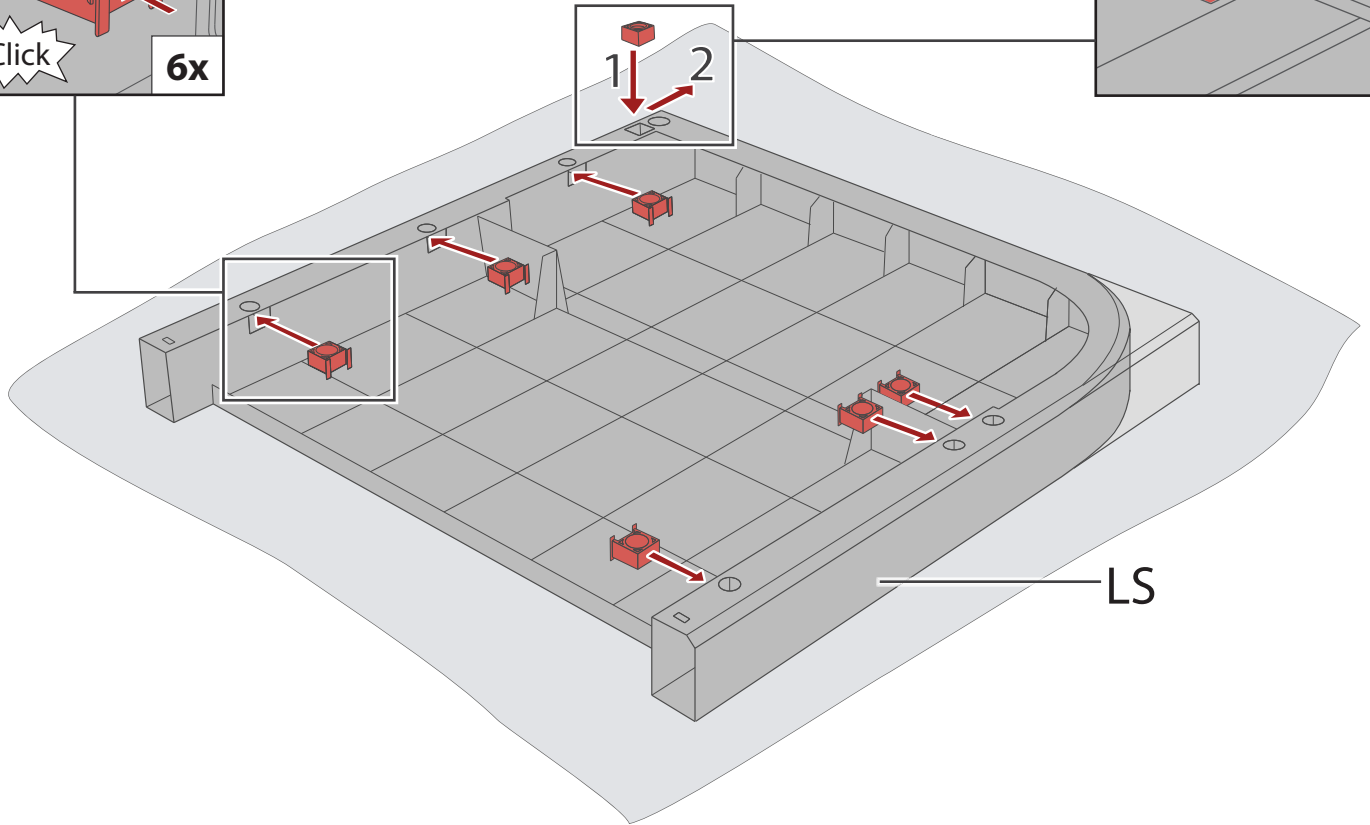
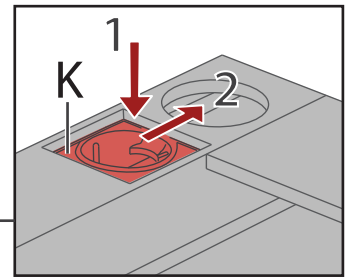
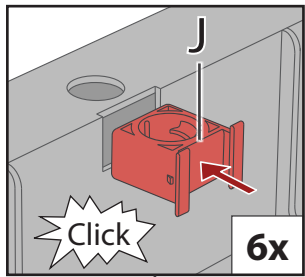

1

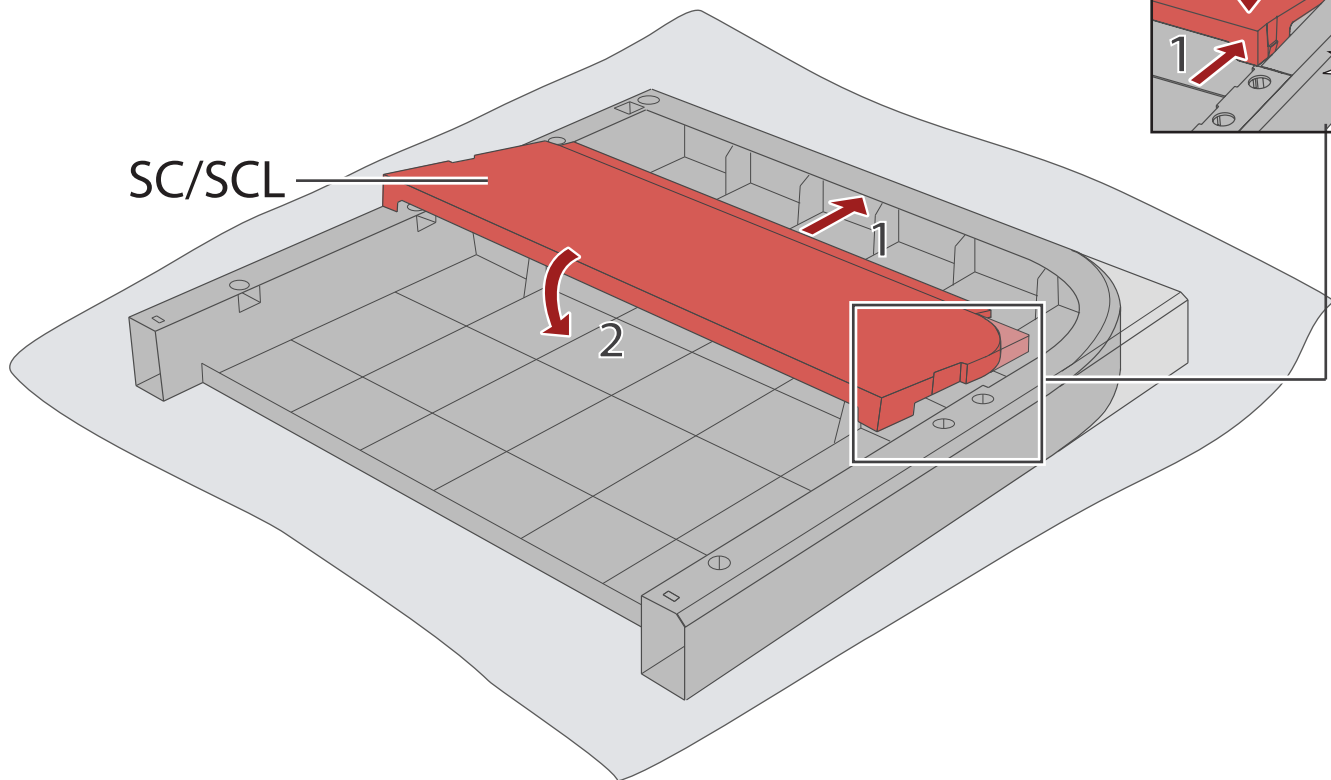
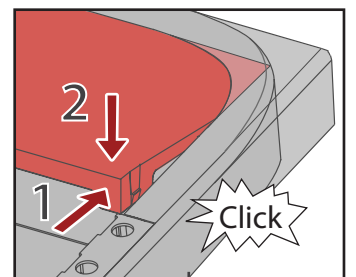

2

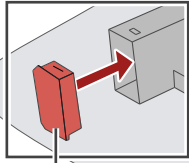
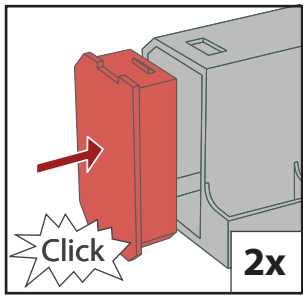

NA

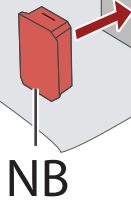

NB

3

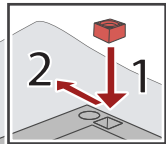
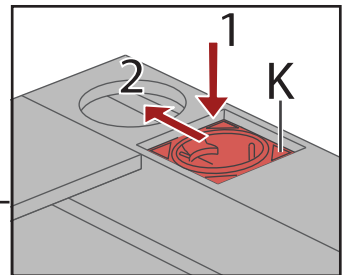
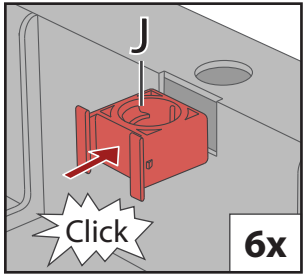

RS

4

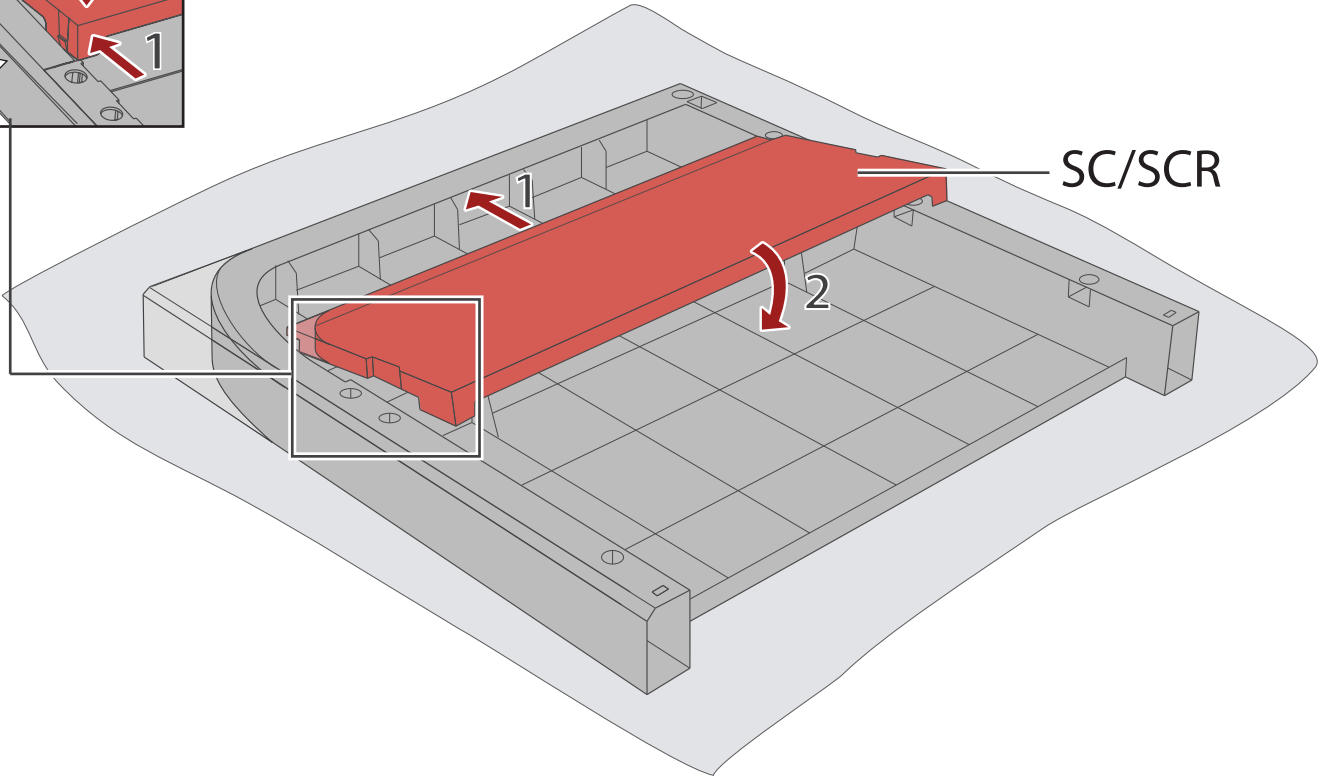
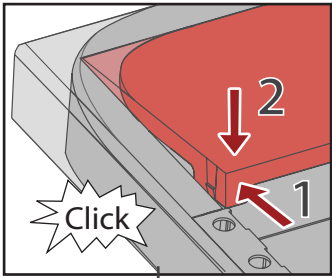

5

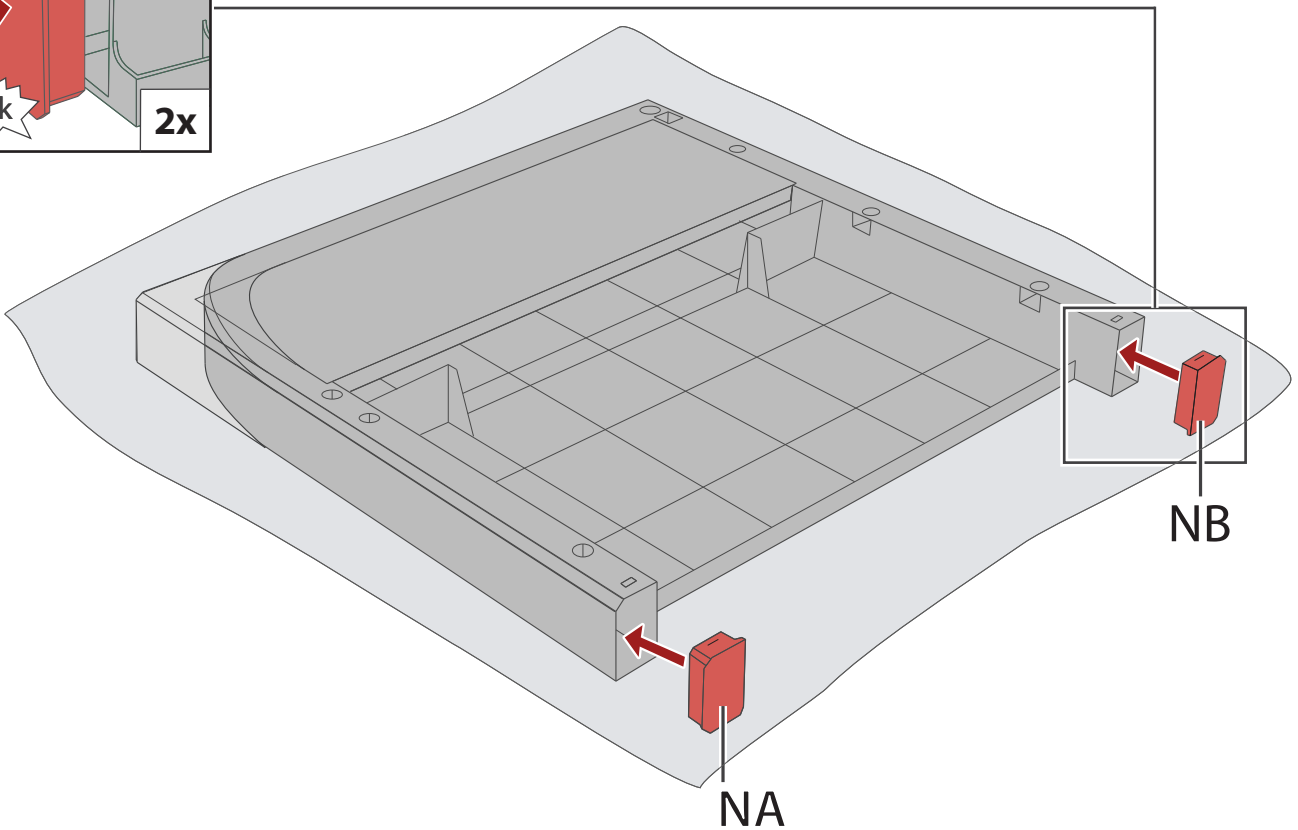
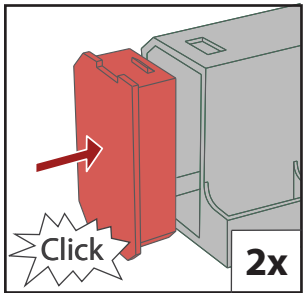

6

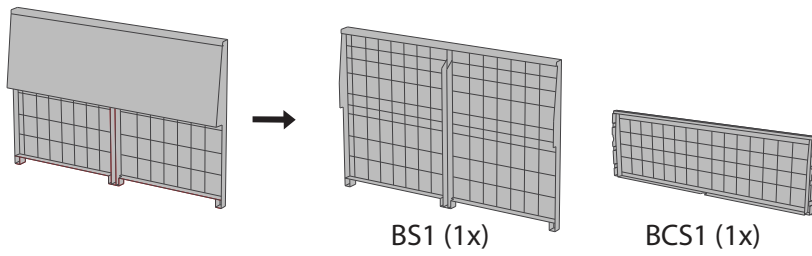
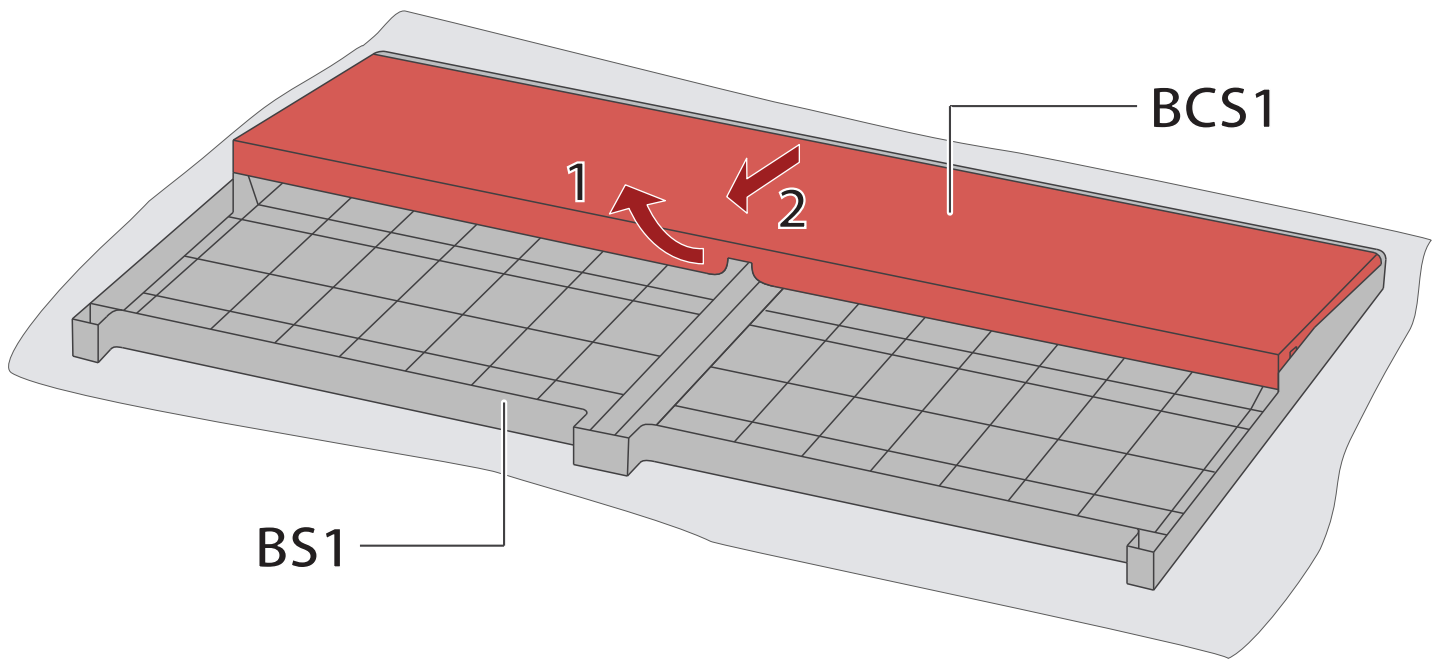

7

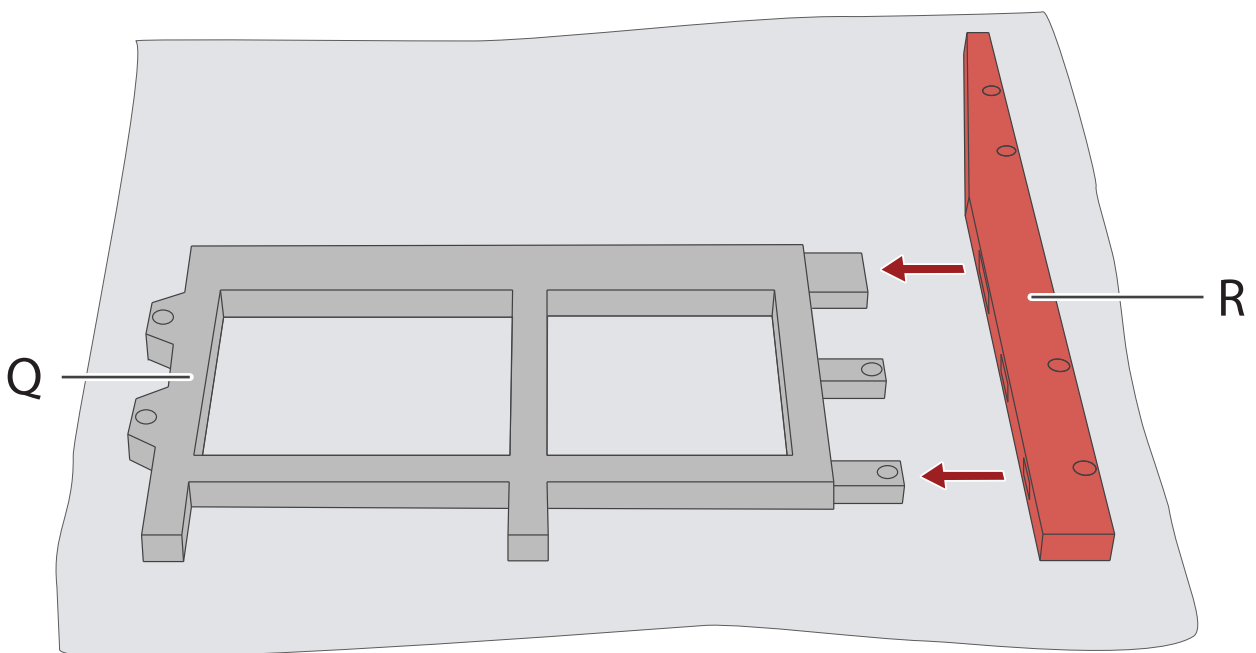

8

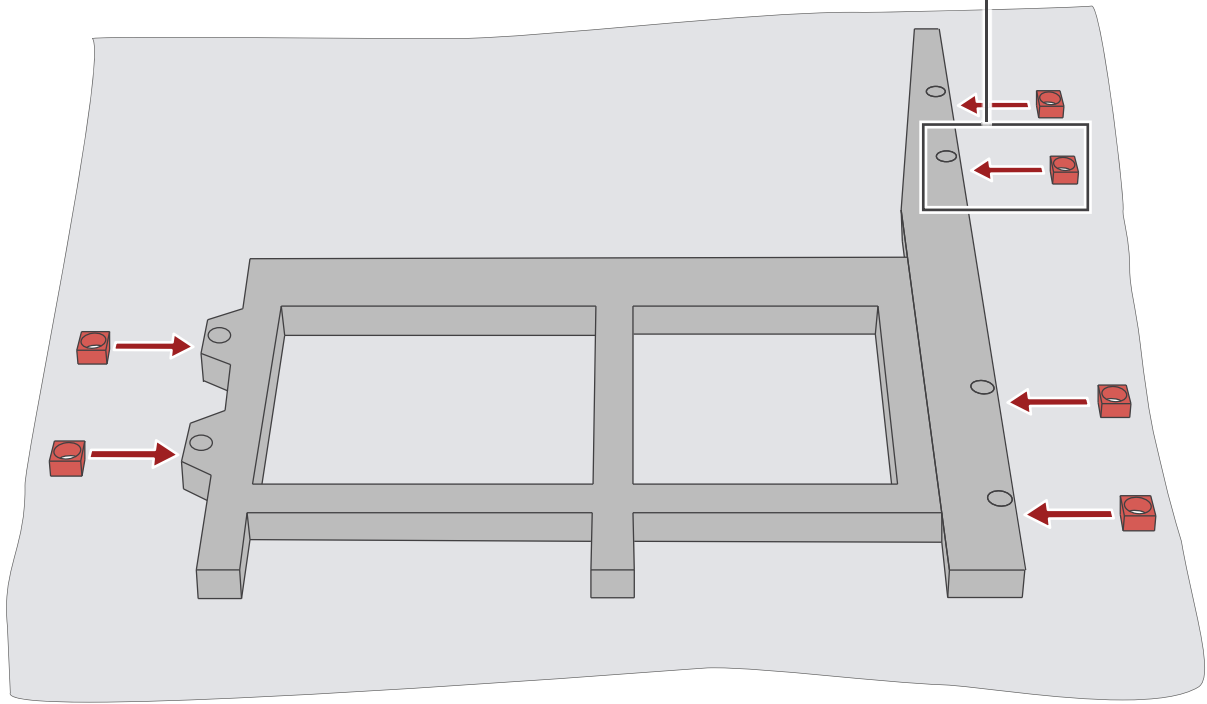
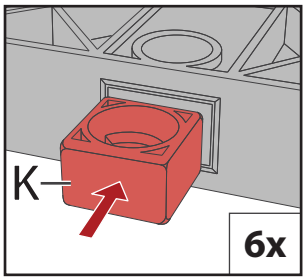

9

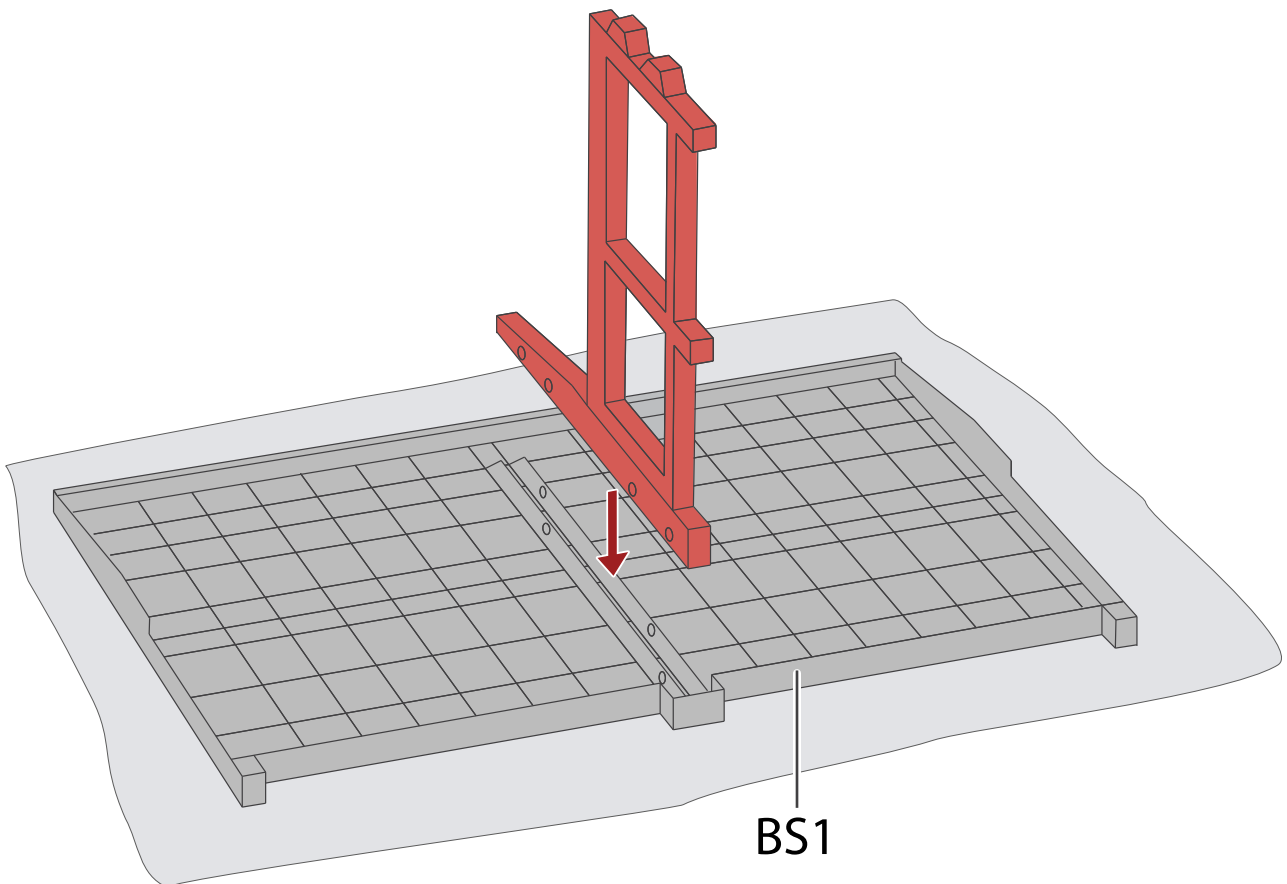

10

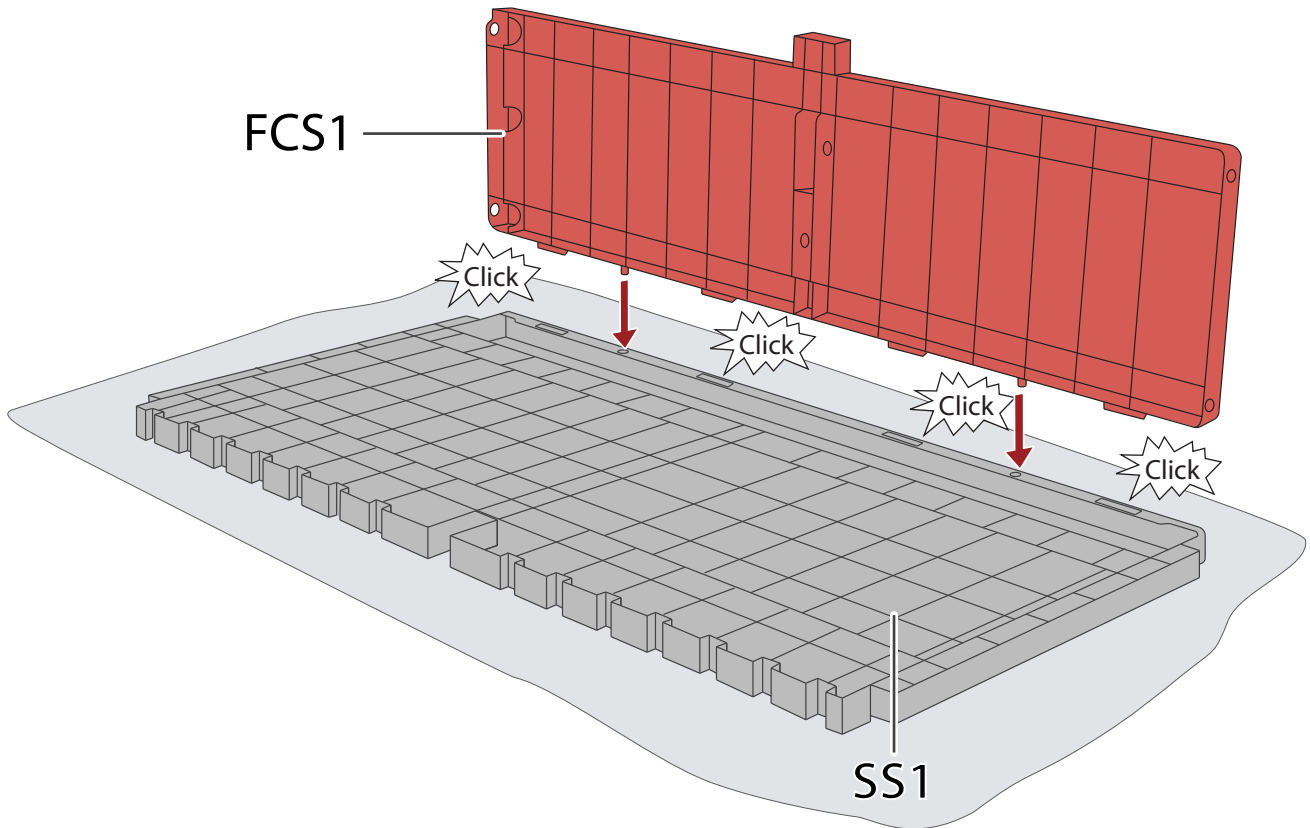
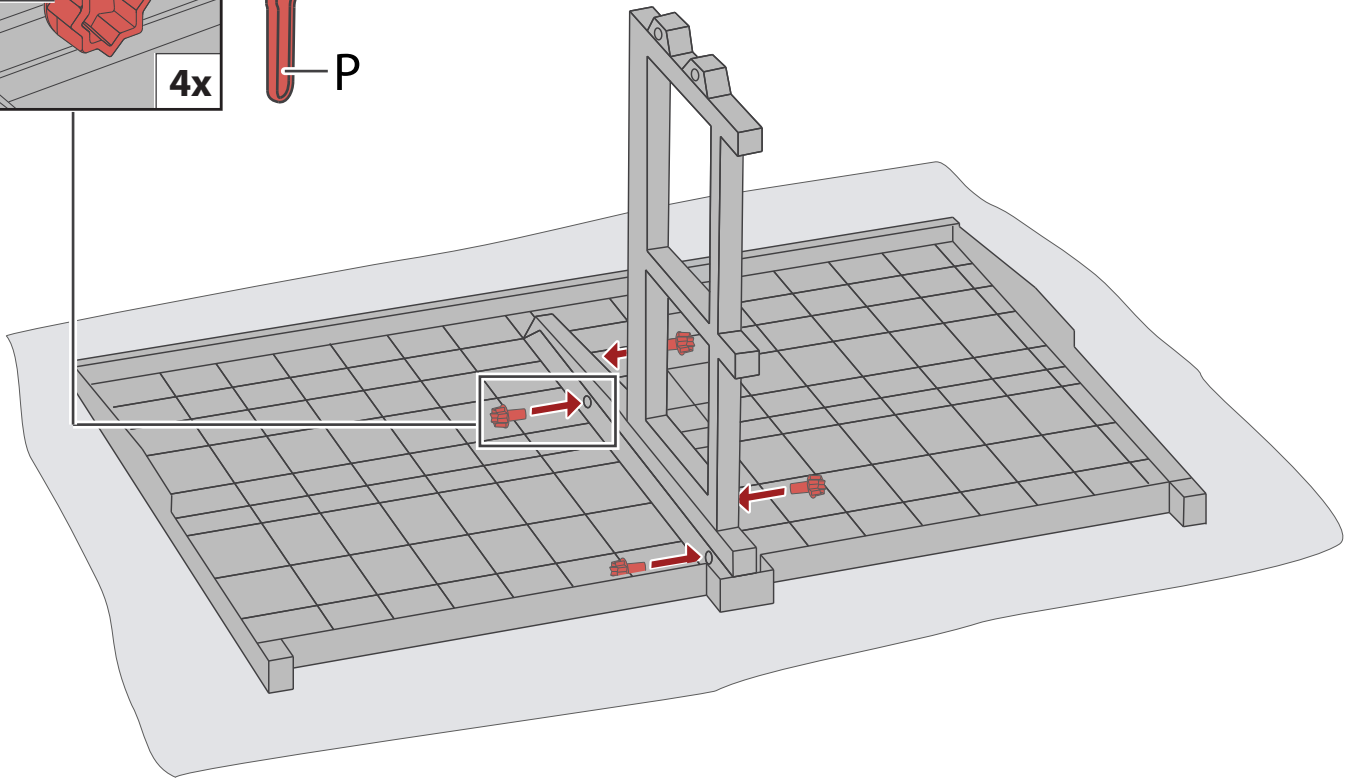
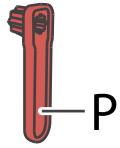
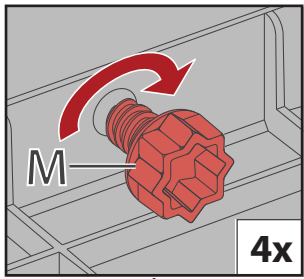

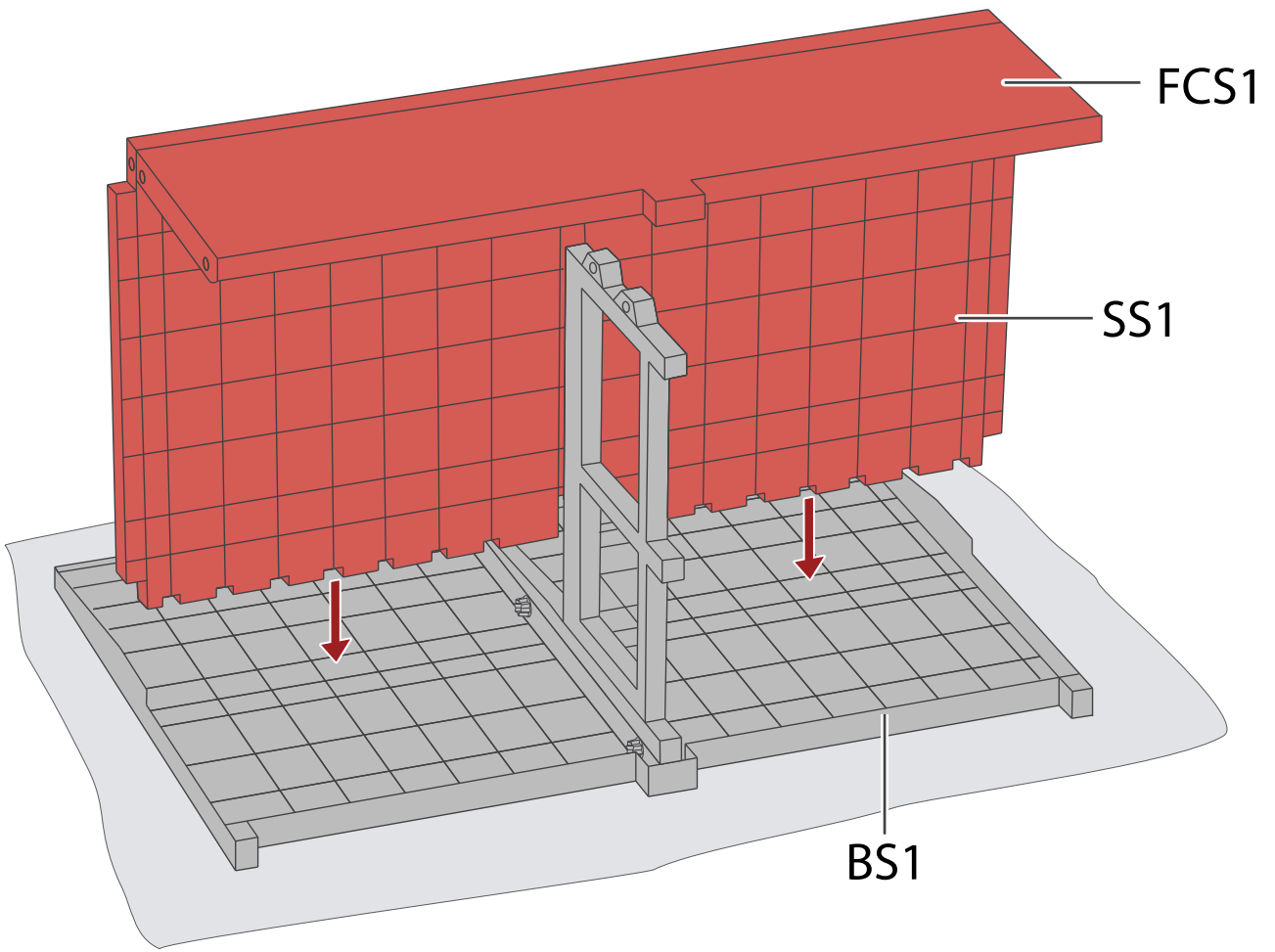

13

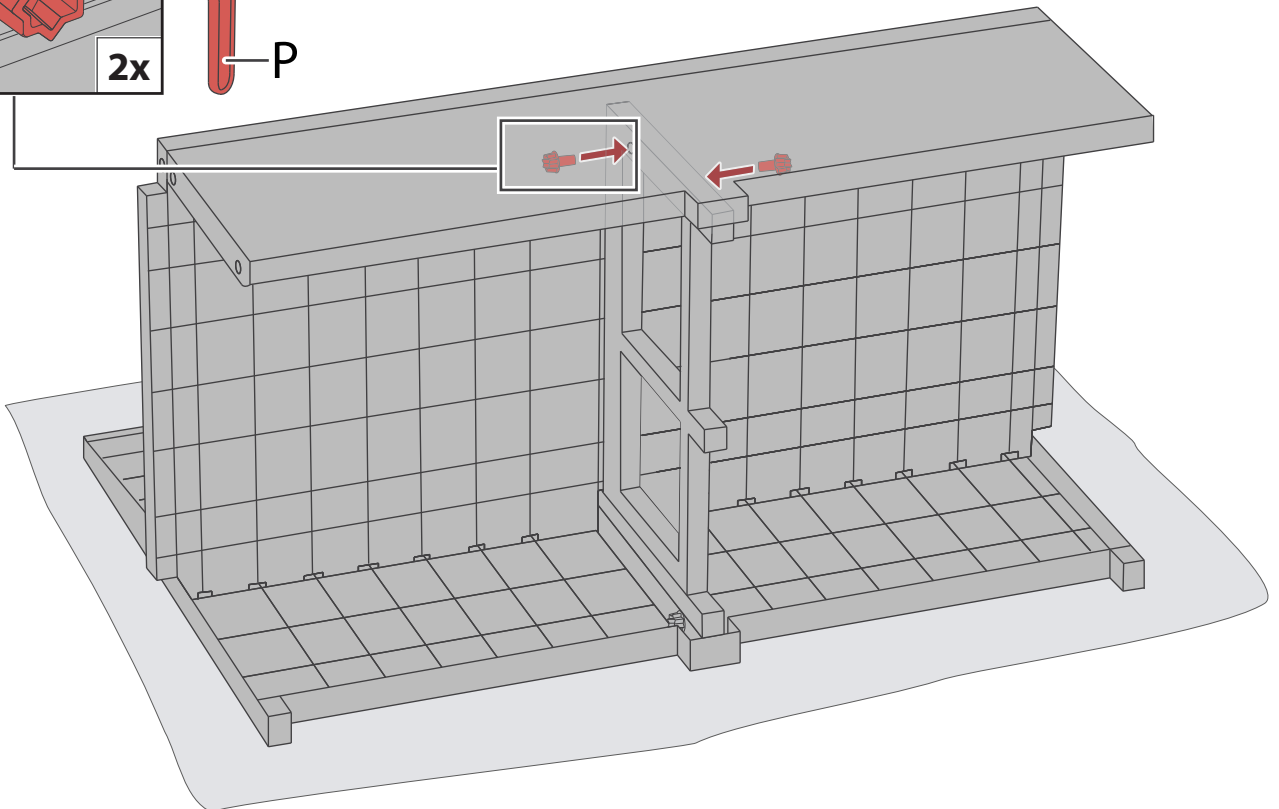
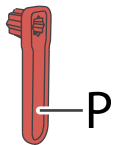
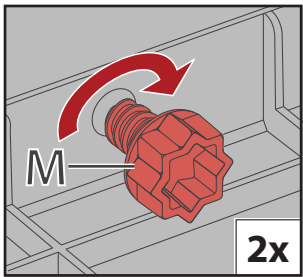

14

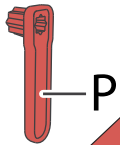
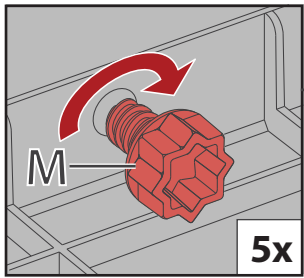

RS

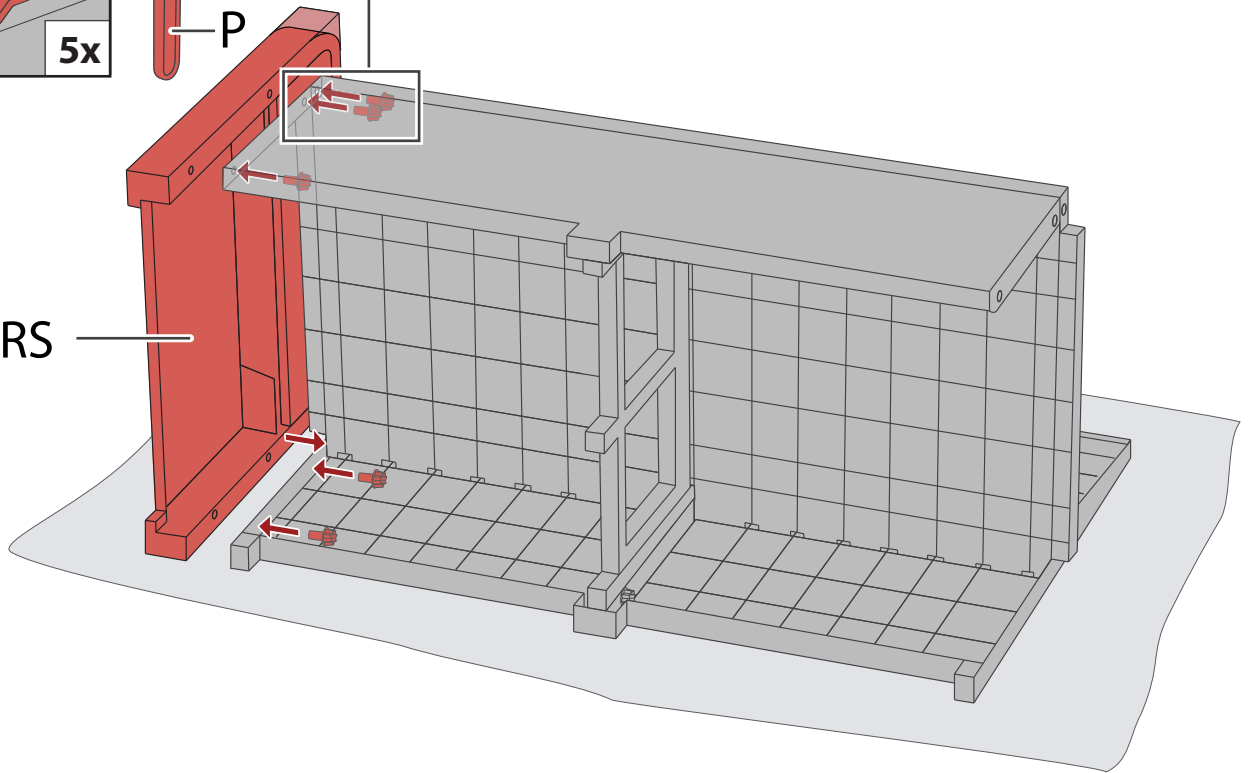

15

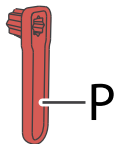
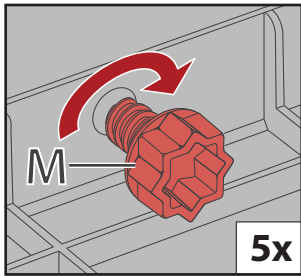

LS

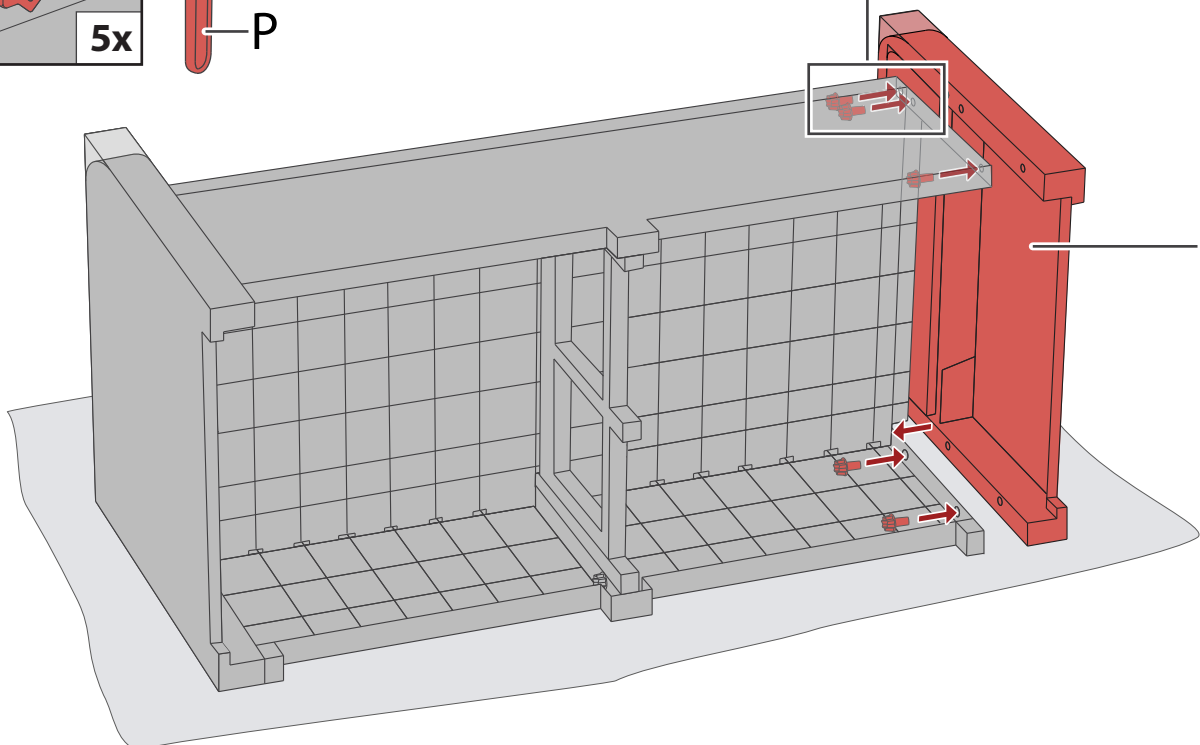

16

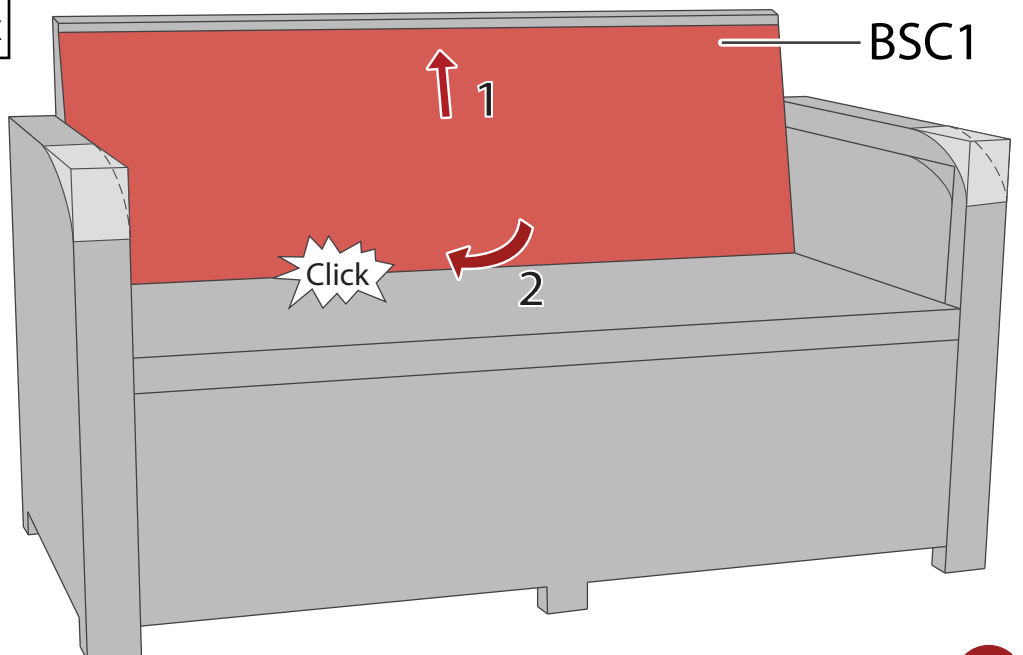
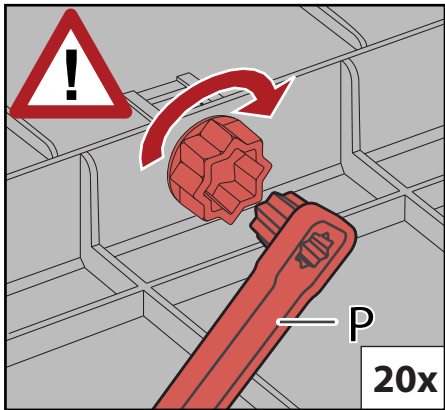
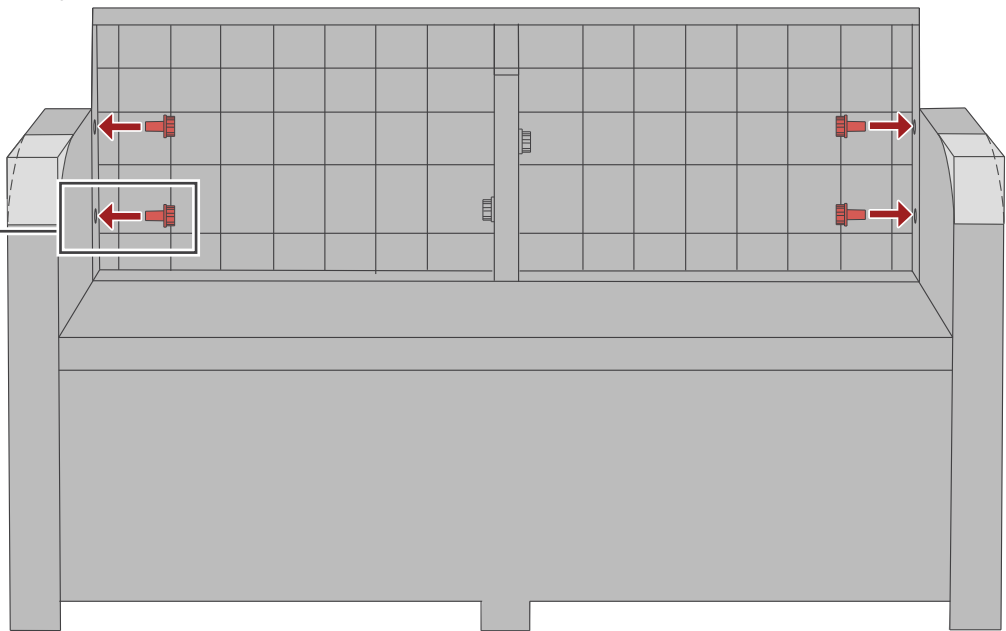
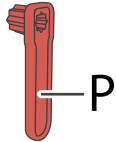
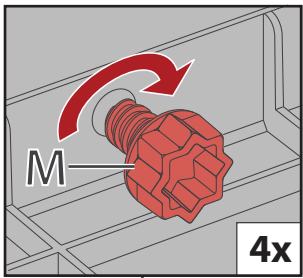

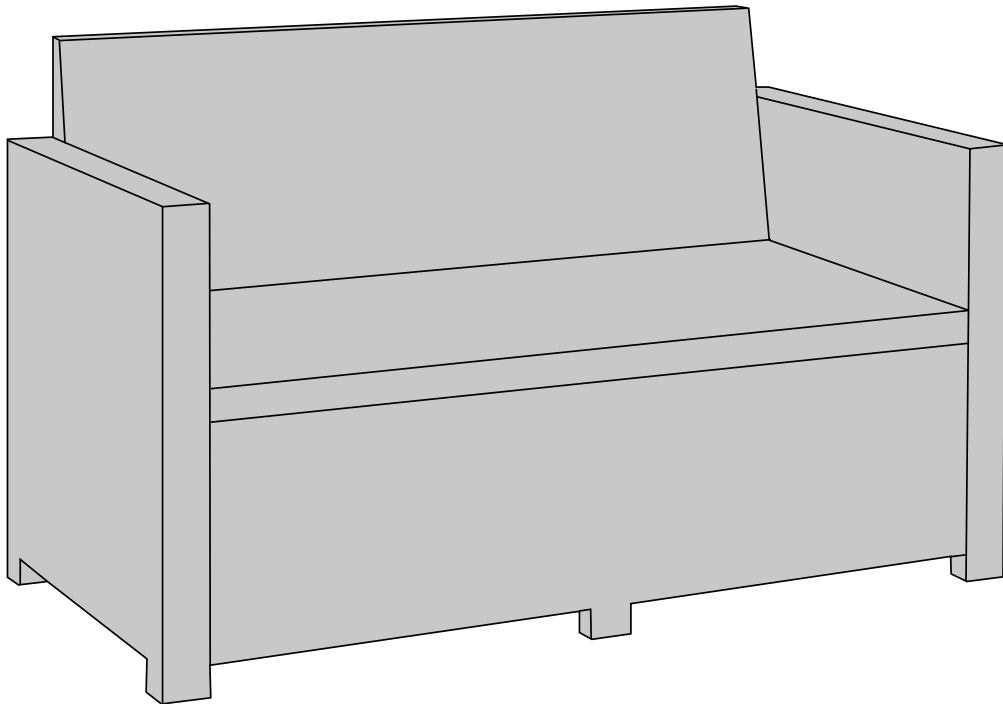
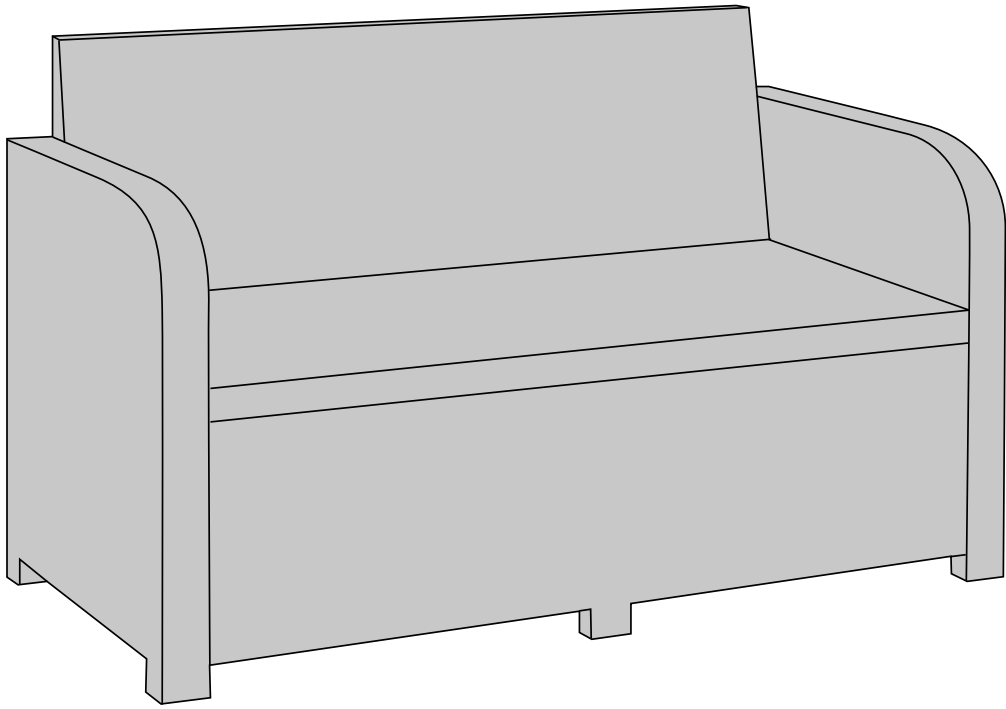

LOUNGE CHAIR

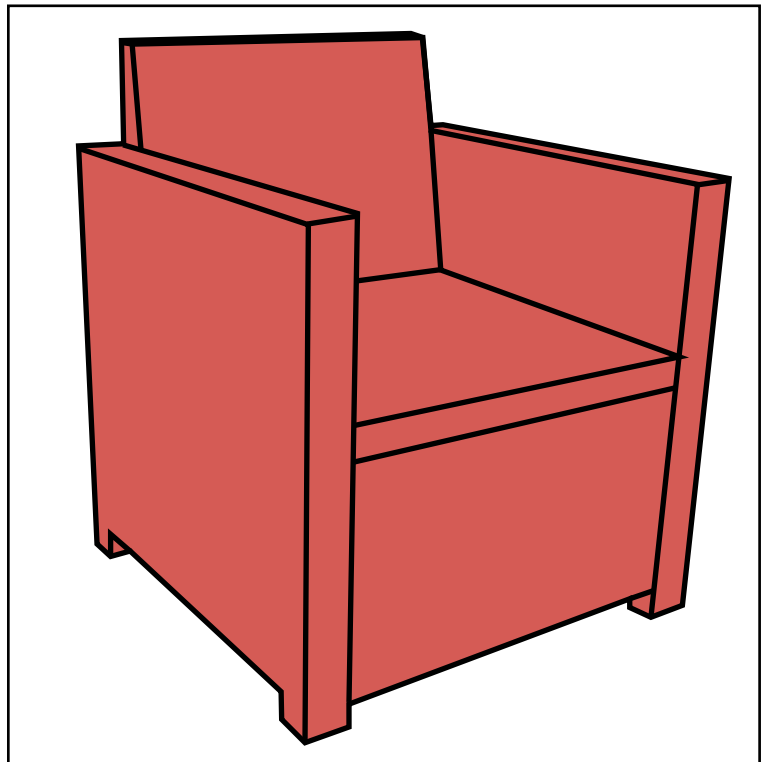
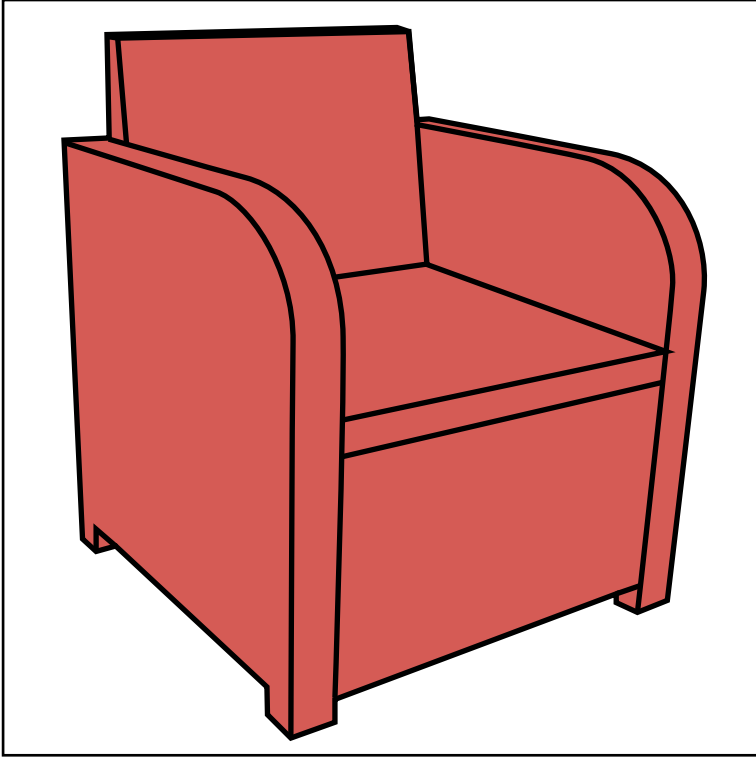

ALLiBERT 

Ericssonstraat 17 | 5121 MK RIJEN | The Netherlands | WWW.ALLIBERT-OUTDOOR.COM



NEN 581

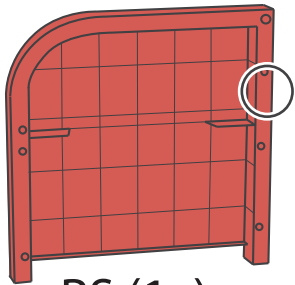
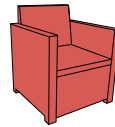
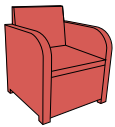

RS (1x)

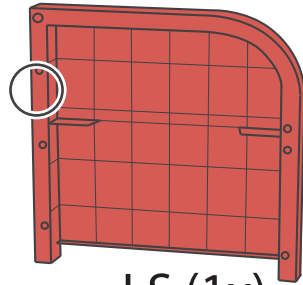

LS (1x)

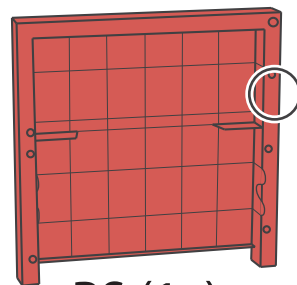

RS (1x)

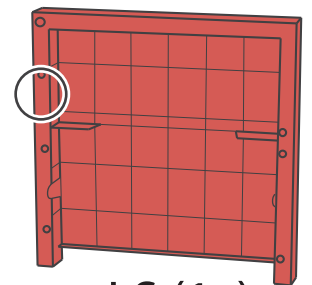

LS (1x)

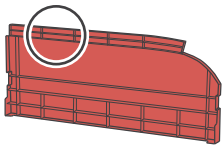

SCR (1x)

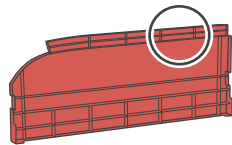

SCL (1x)

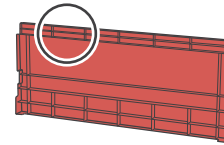

SC (2x)

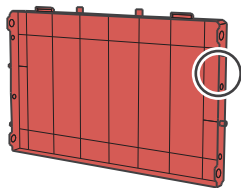

F1 (1x)

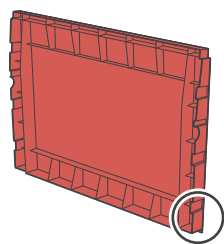

BC1 (1x)

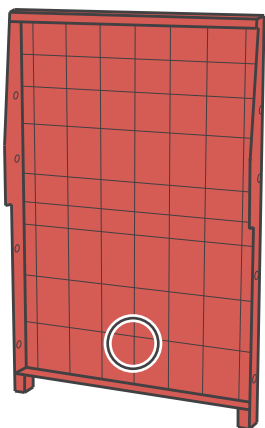

B1 (1x)

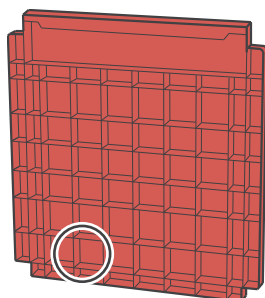

S1 (1x)

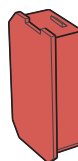

NA (2x)

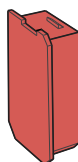

NB (2x)

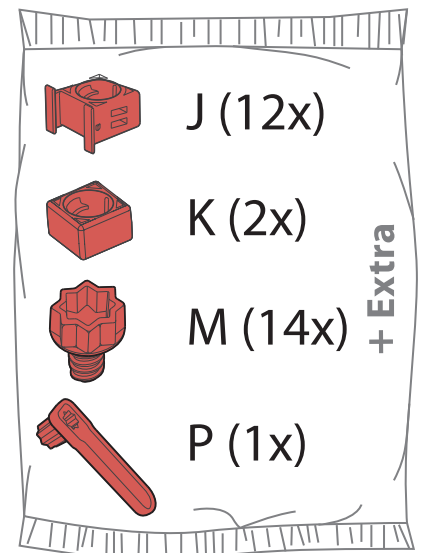

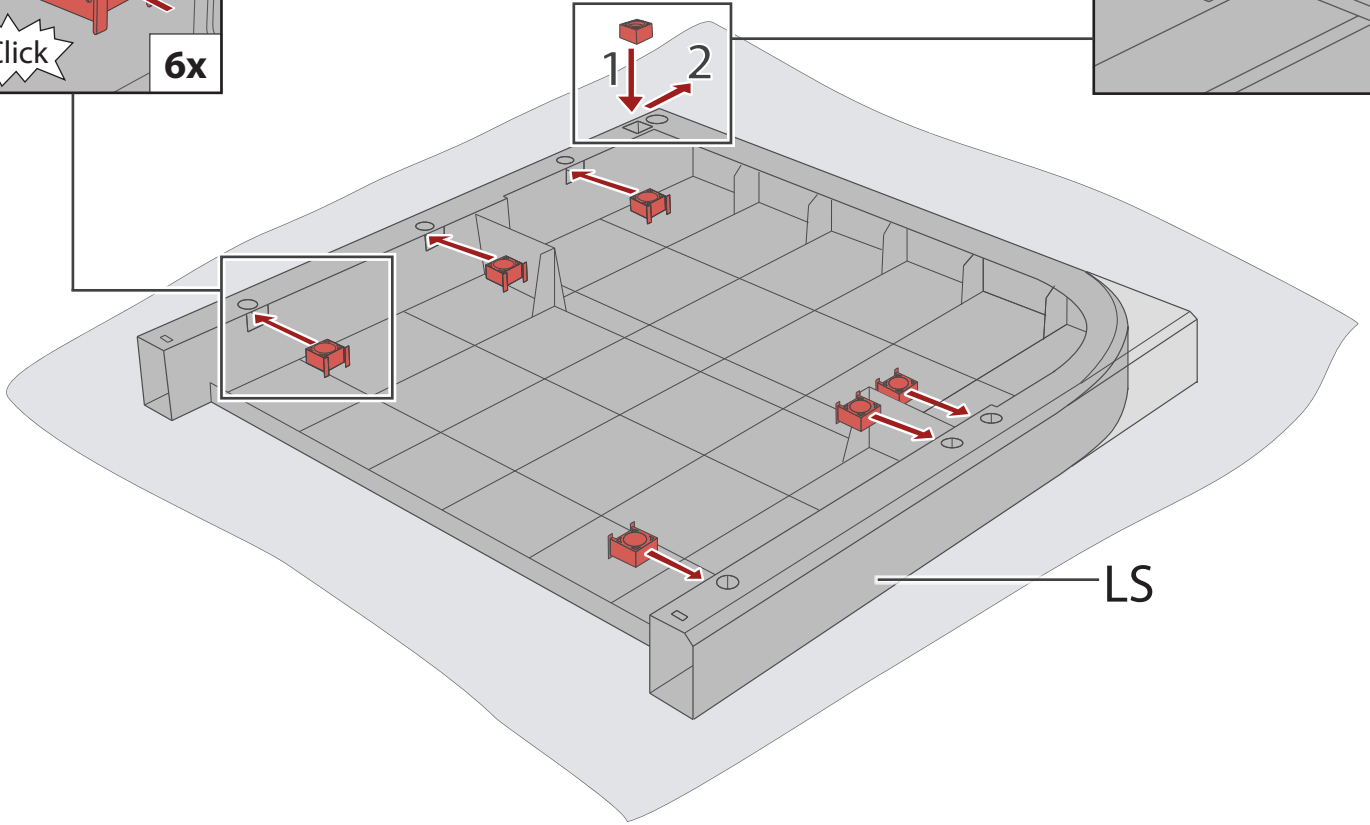
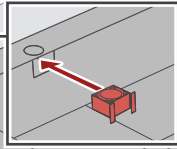
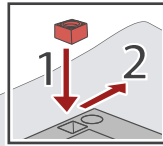
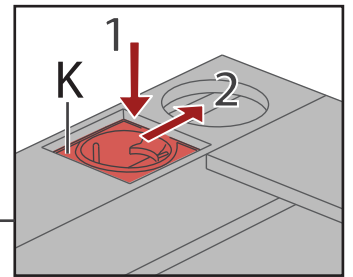
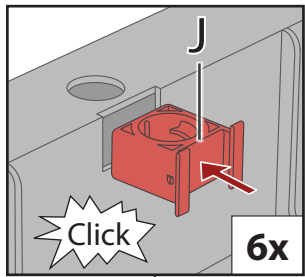

1

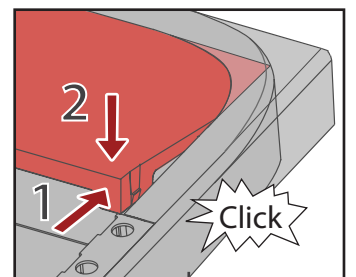

SC/SCL

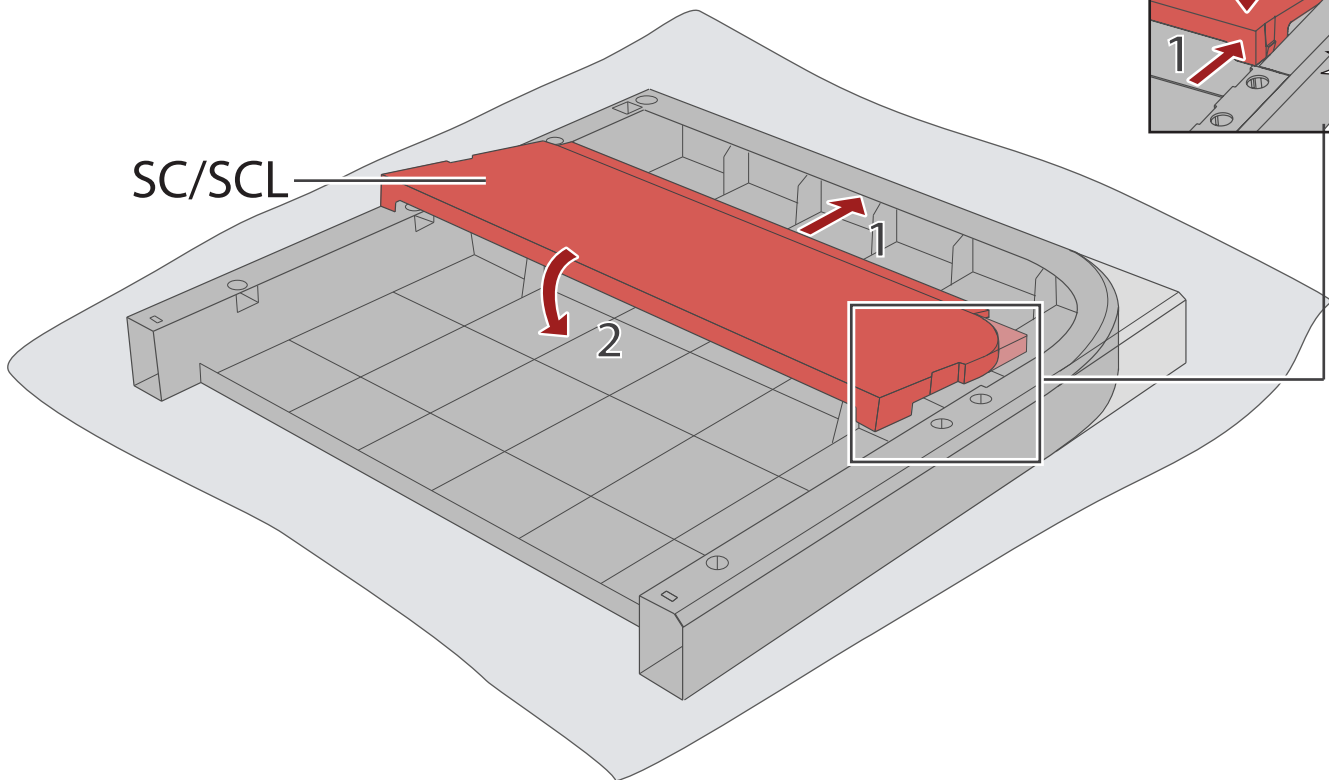

2

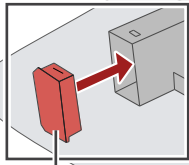
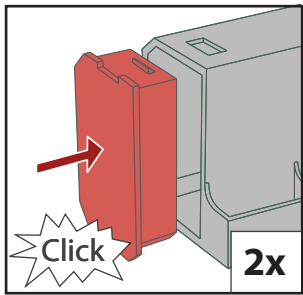

NA



NB

3

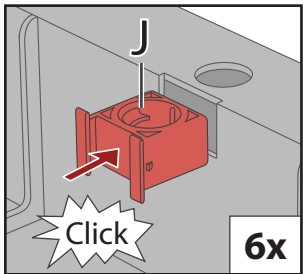

Click

6x

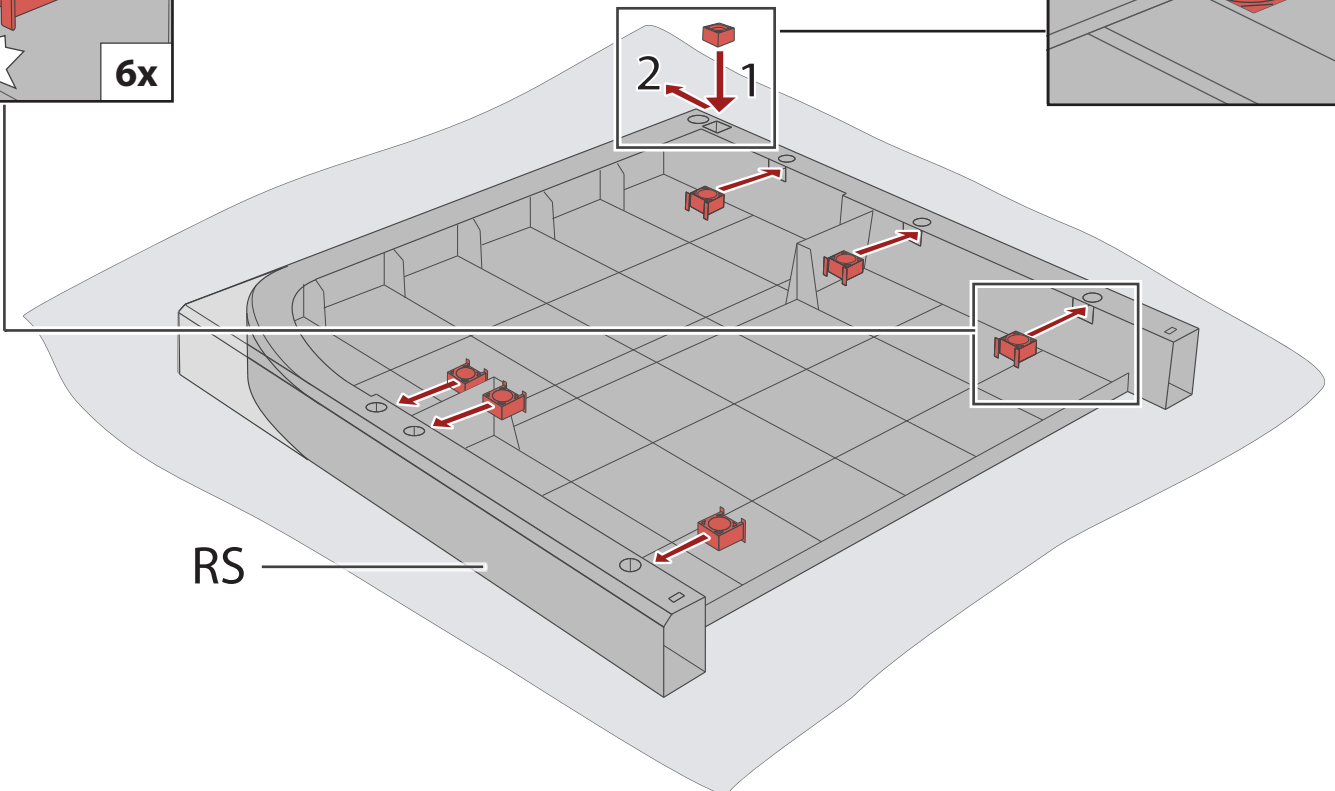

RS

4

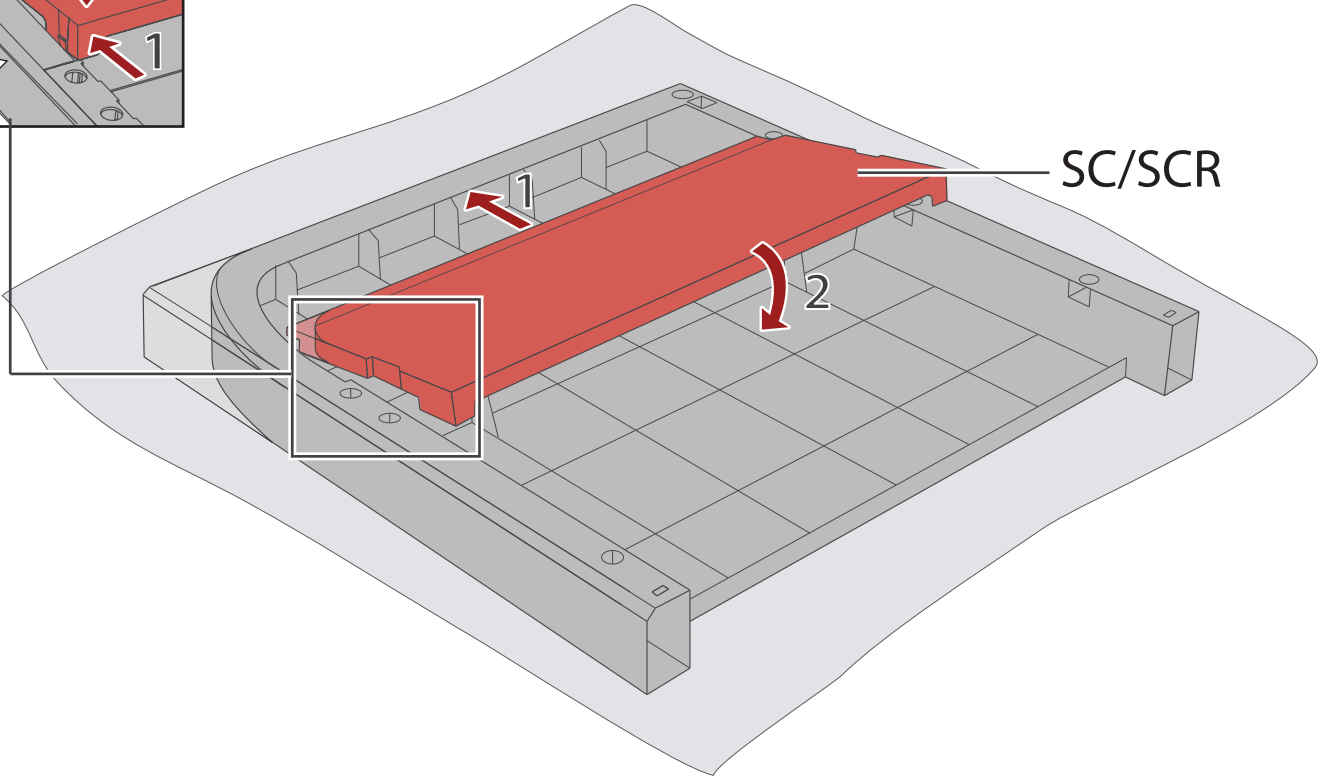
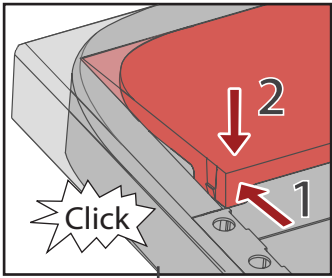

5

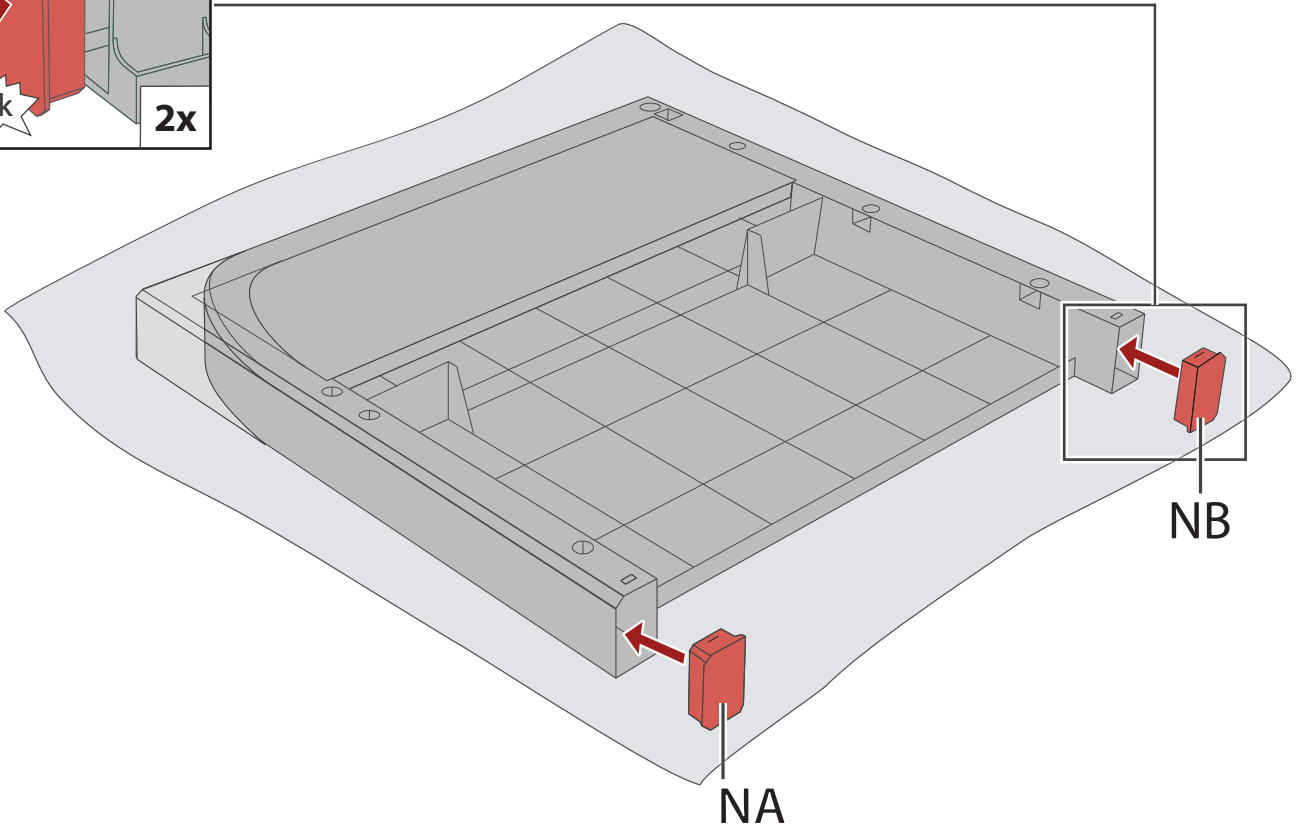
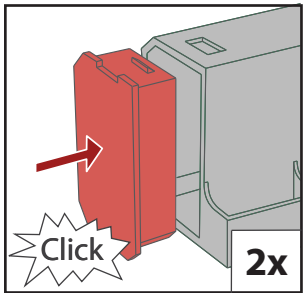

6

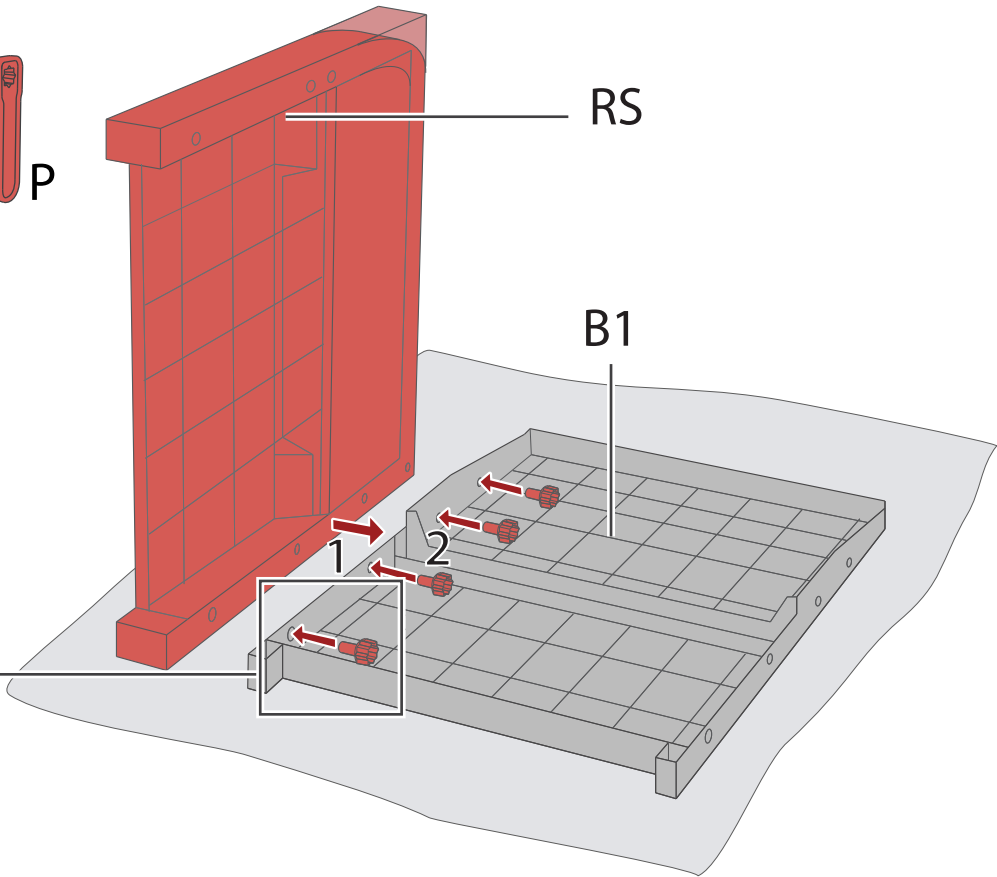
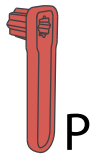
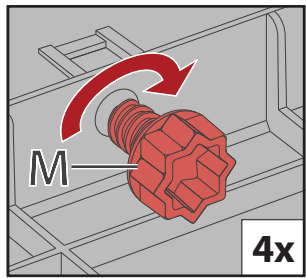

7

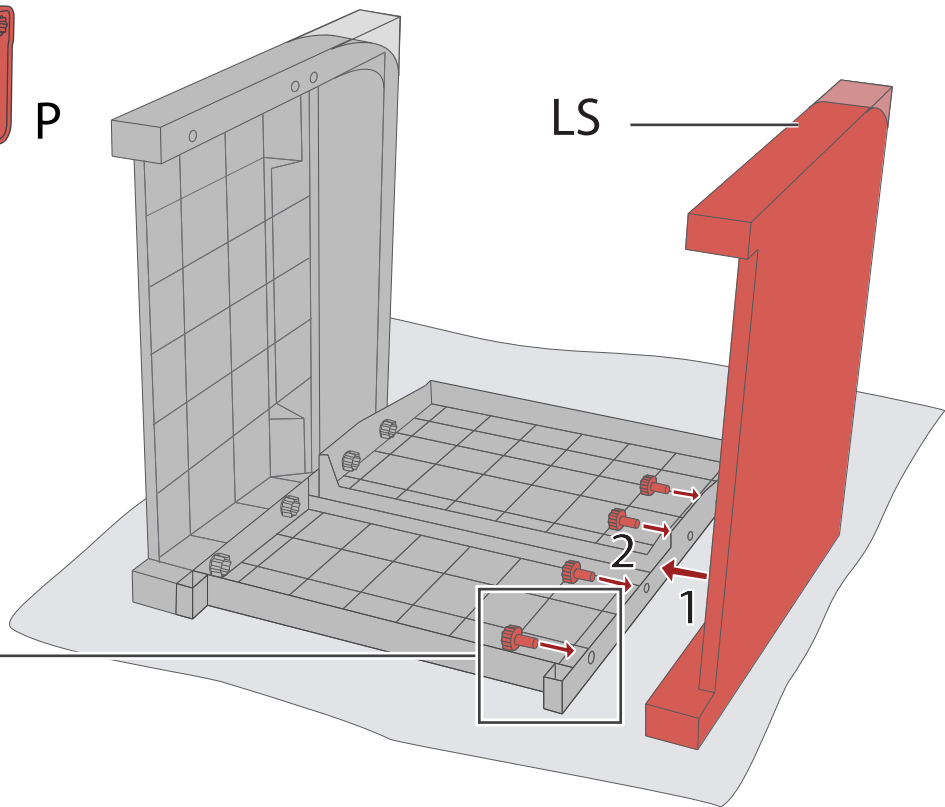
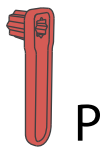
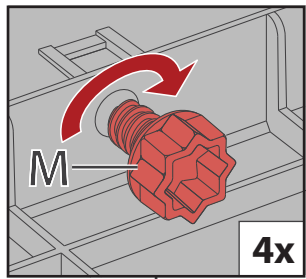

8

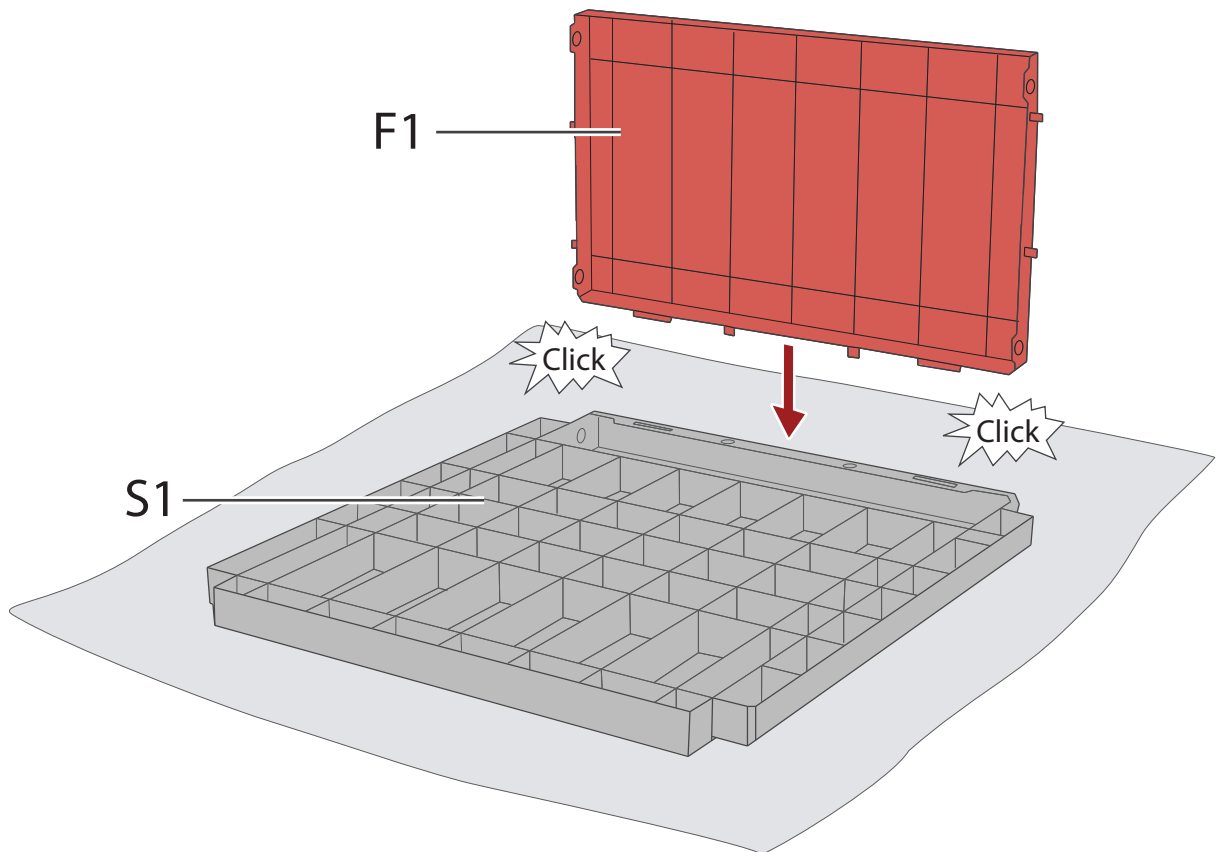

9

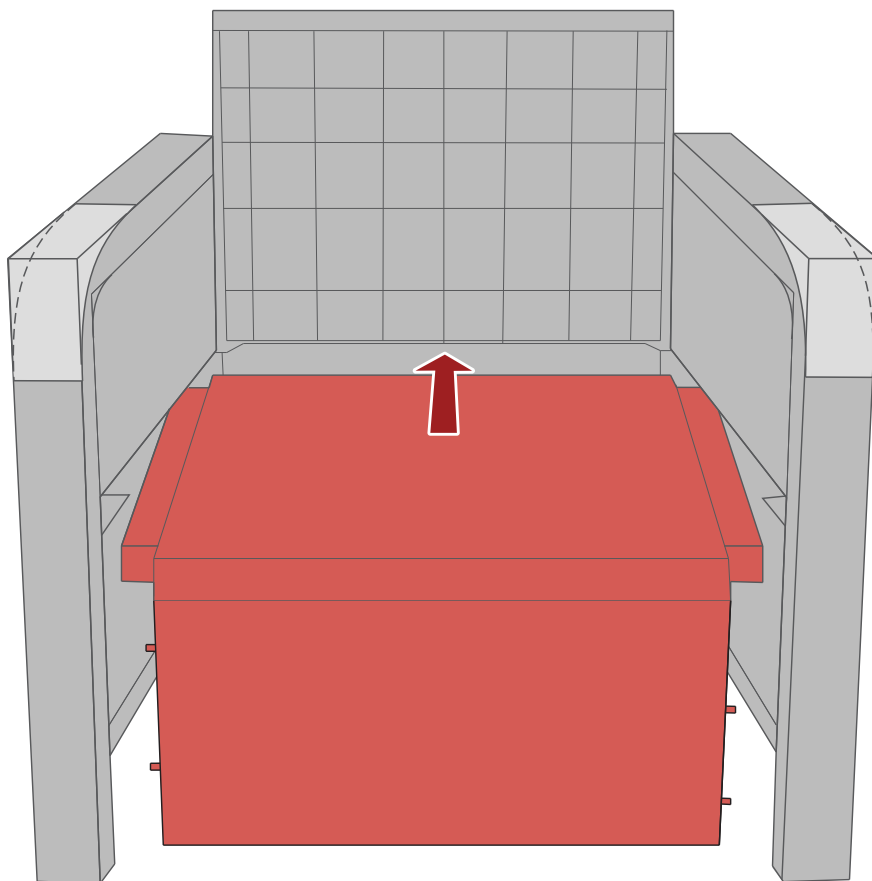

10

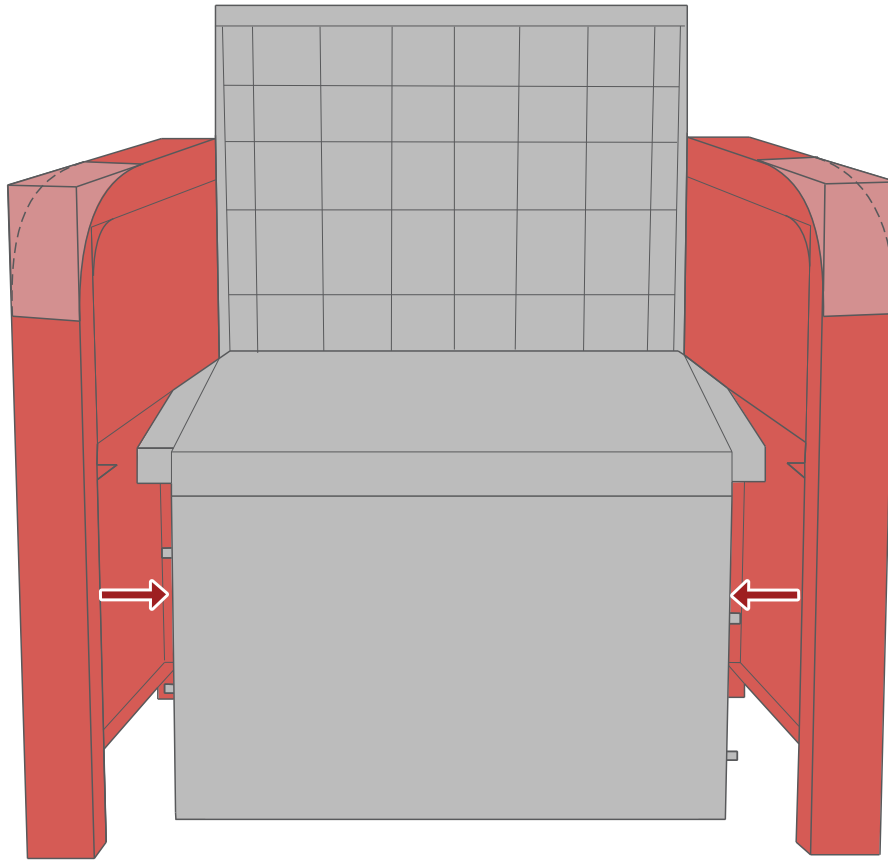

11

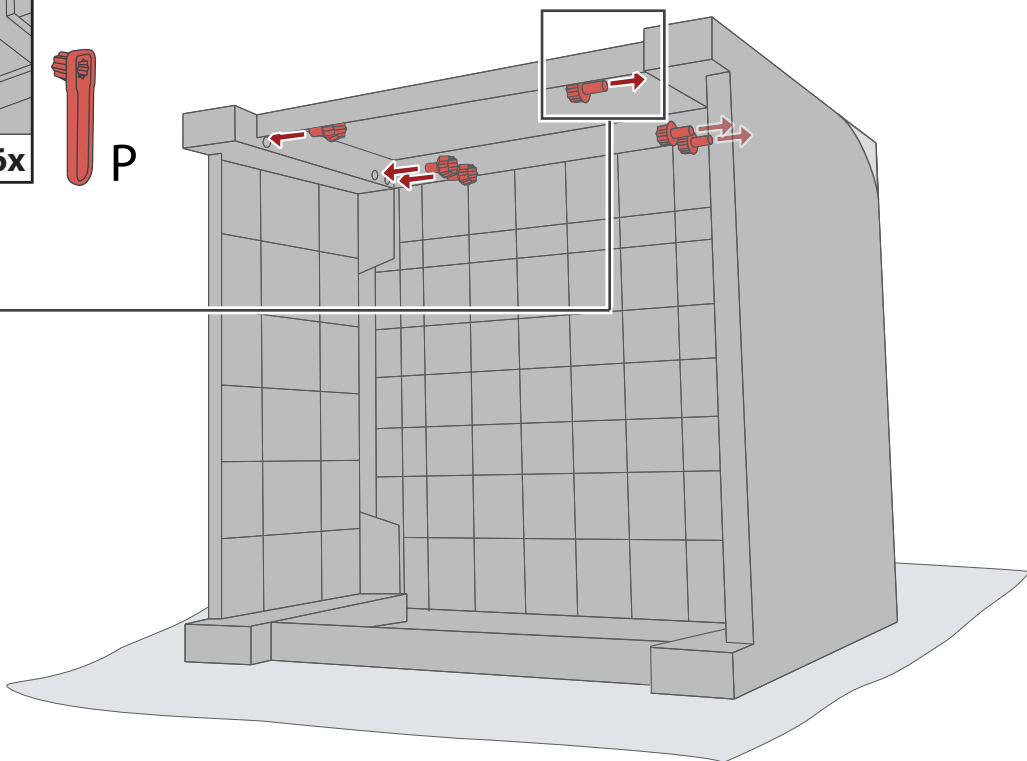
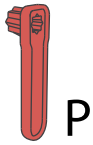
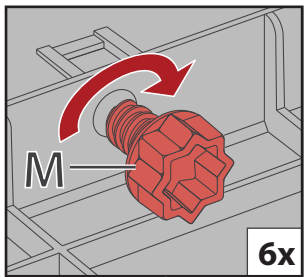

12

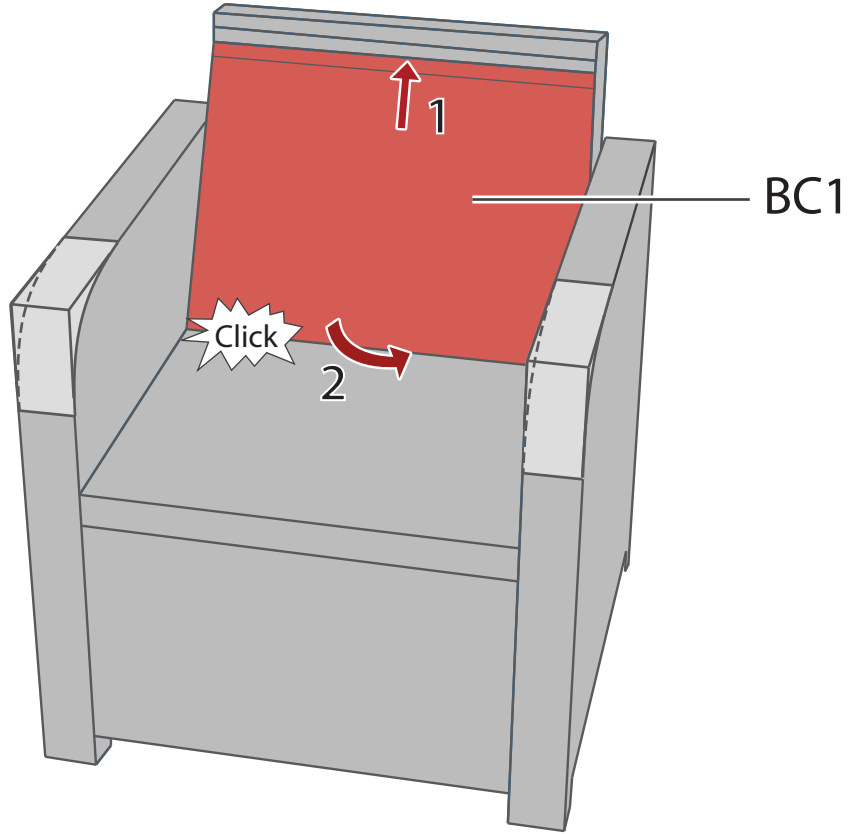
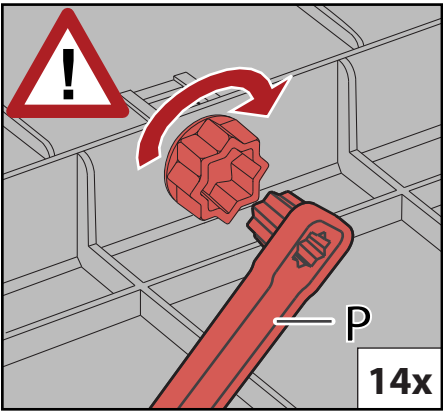

13

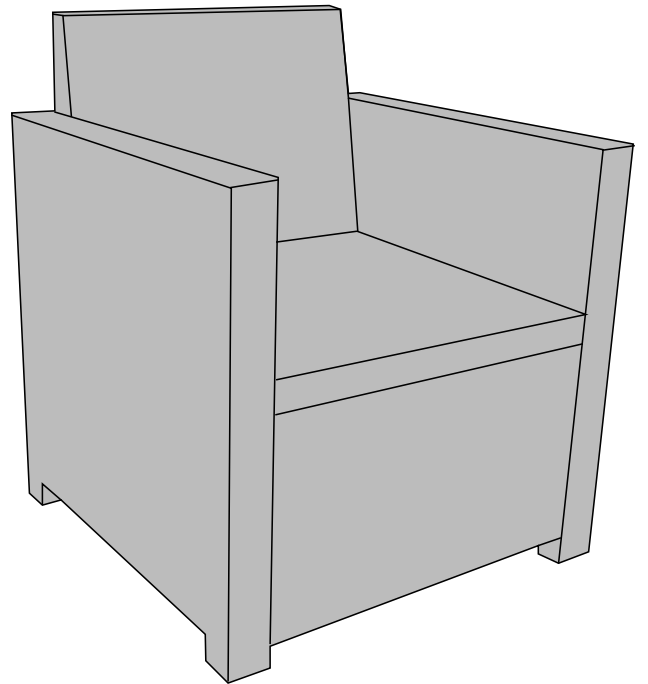
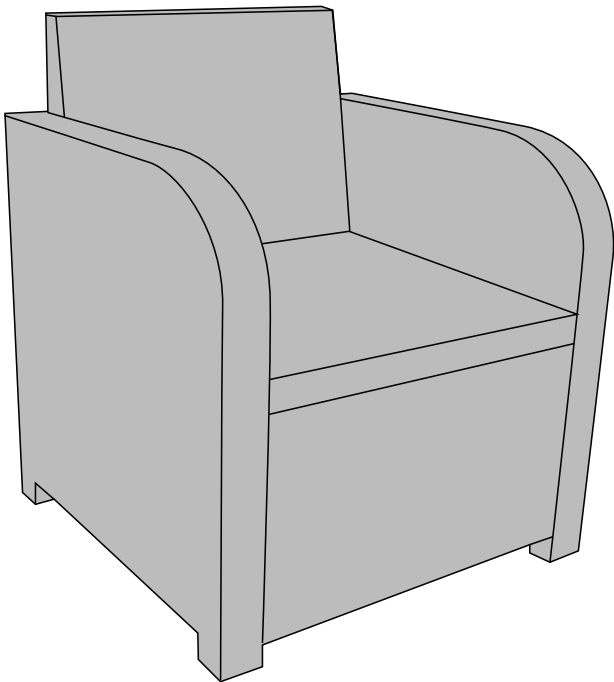

14

LOUNGE TABLE

93 x 59 cm

9012



59 x 59 cm

9019

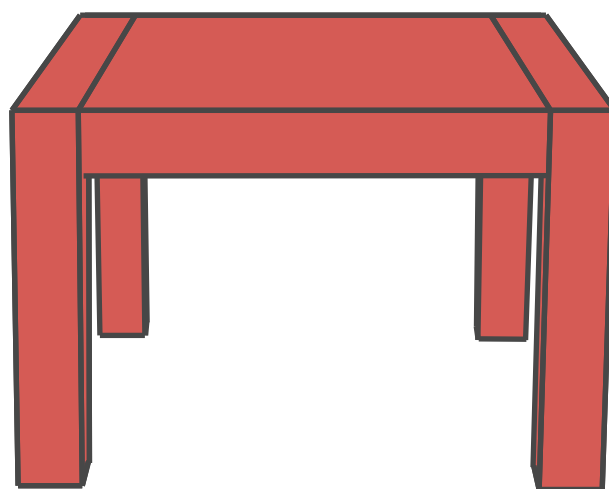

ALLIBERT 



NEN 581

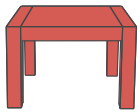

59x59cm

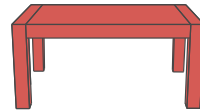

93x59cm

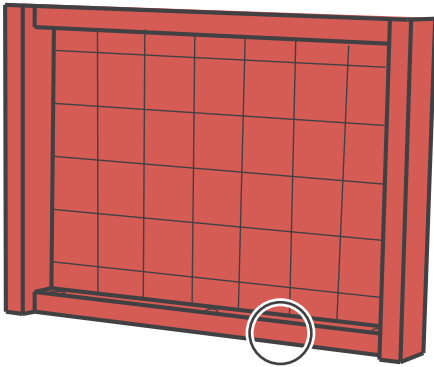

TTS (1x)

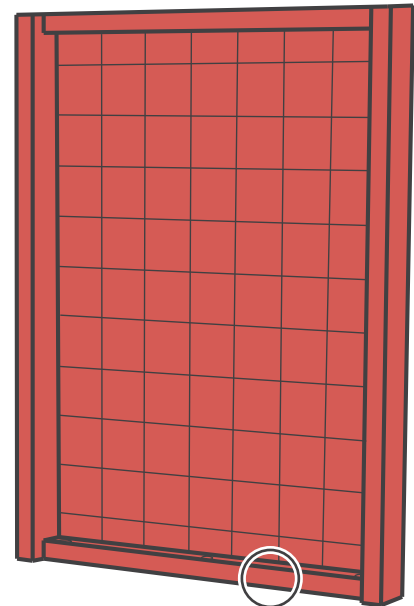

TT (1x)

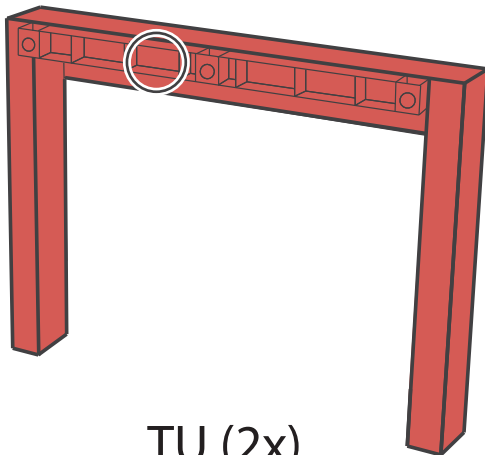

TU (2x)

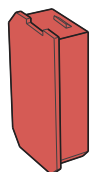

NA (2x)

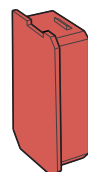

NB (2x)

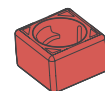
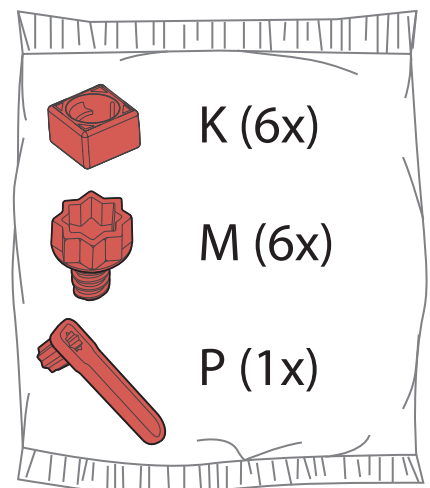

K (6x)



M (6x)

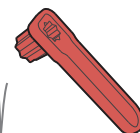

P (1x)

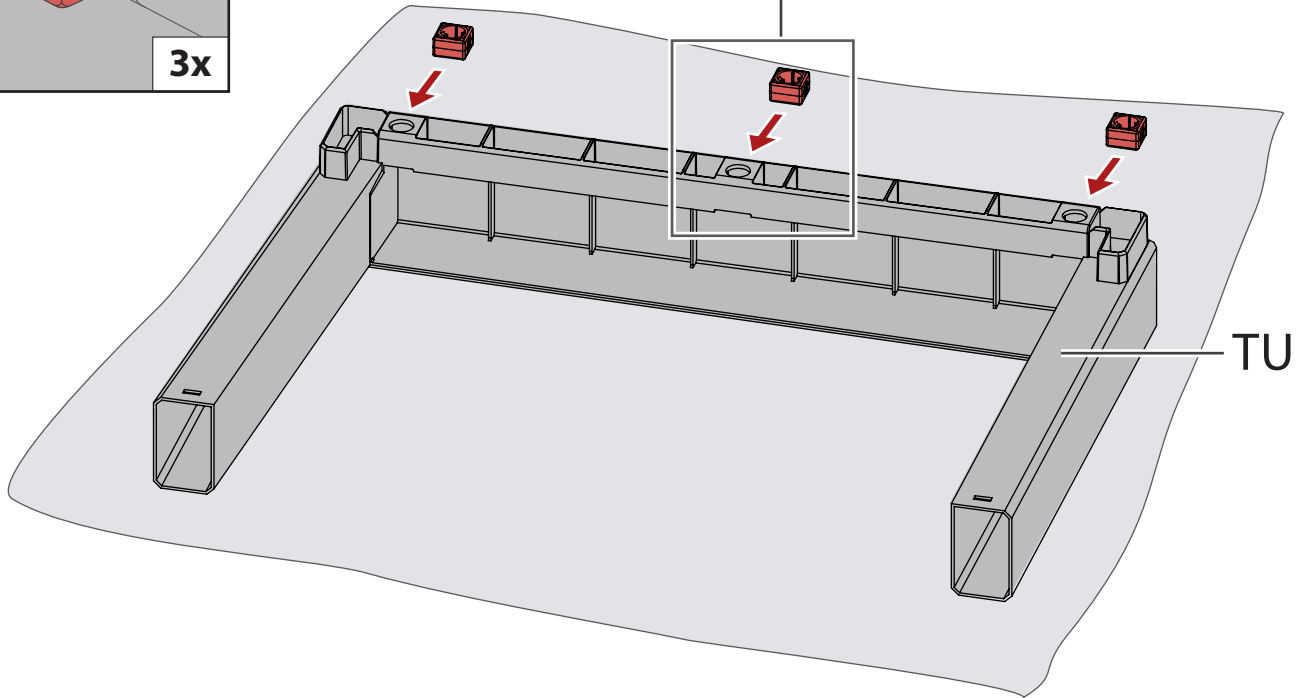
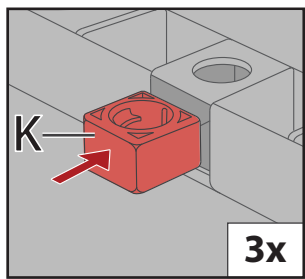

2x

1

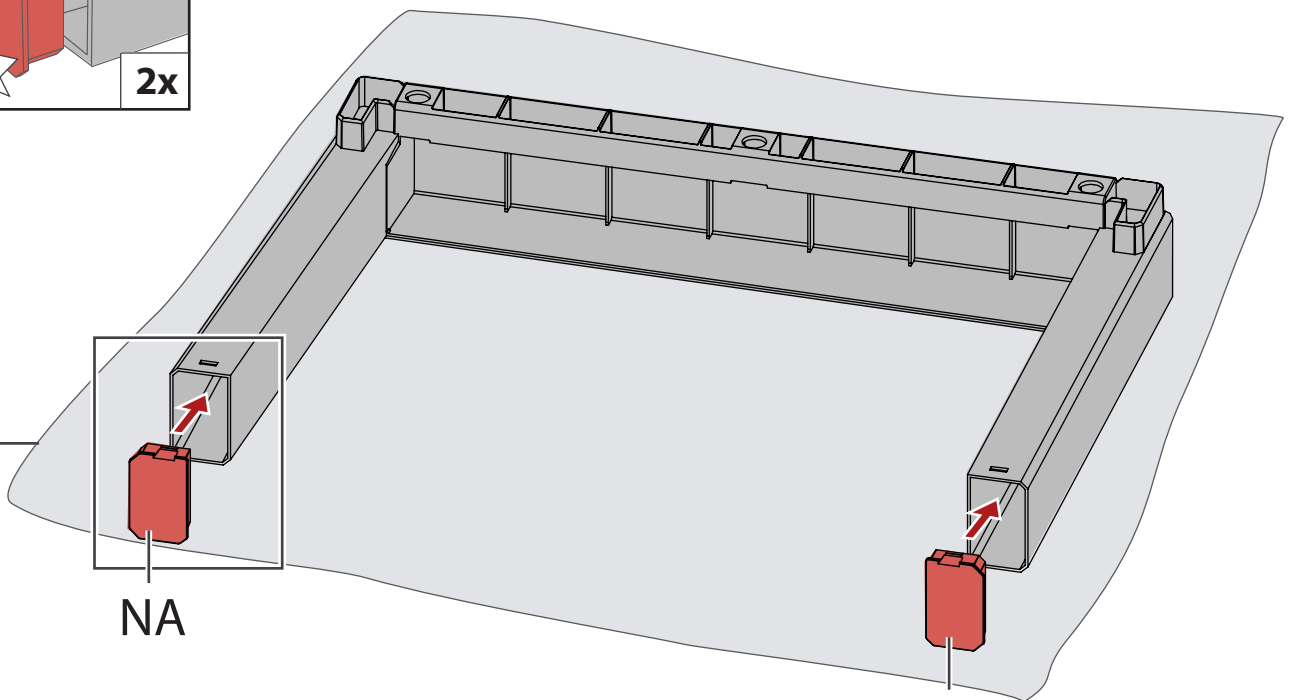
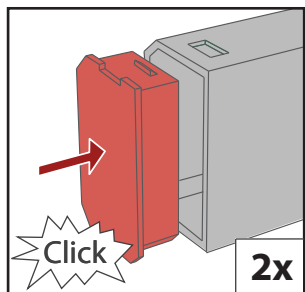

2x

2

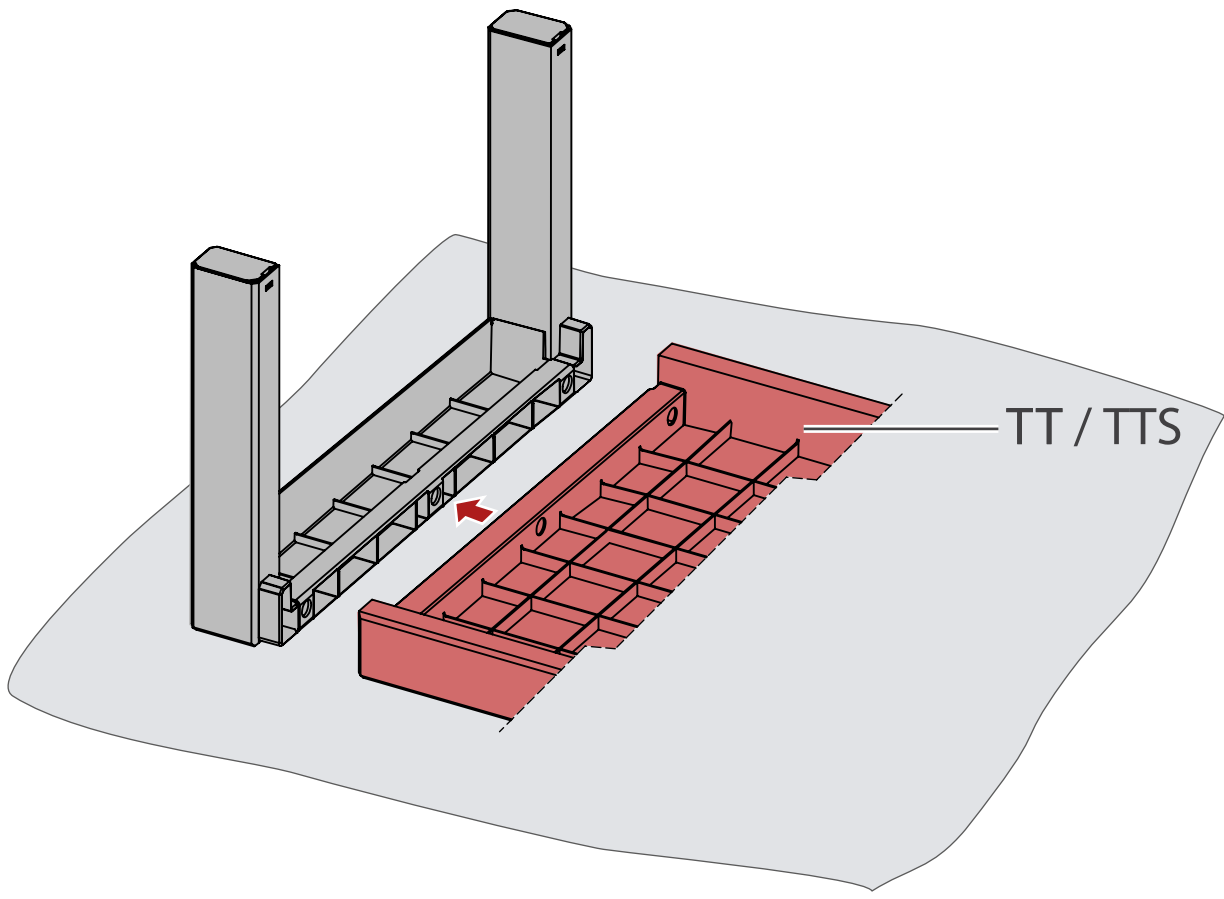

3

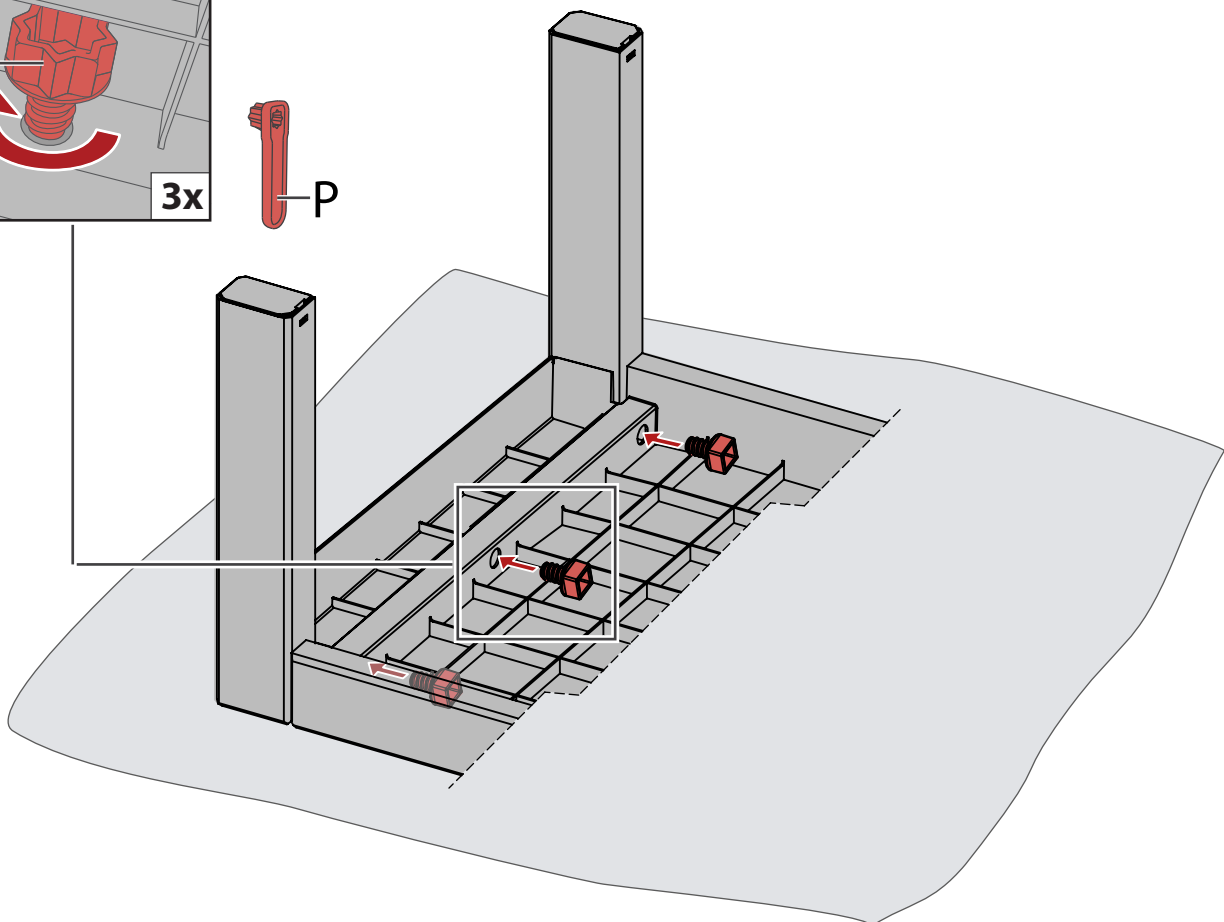
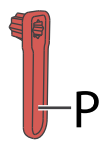
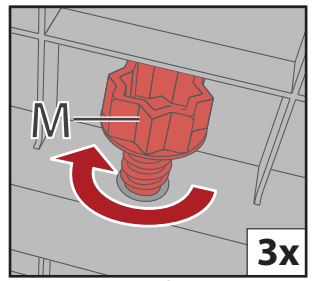

4

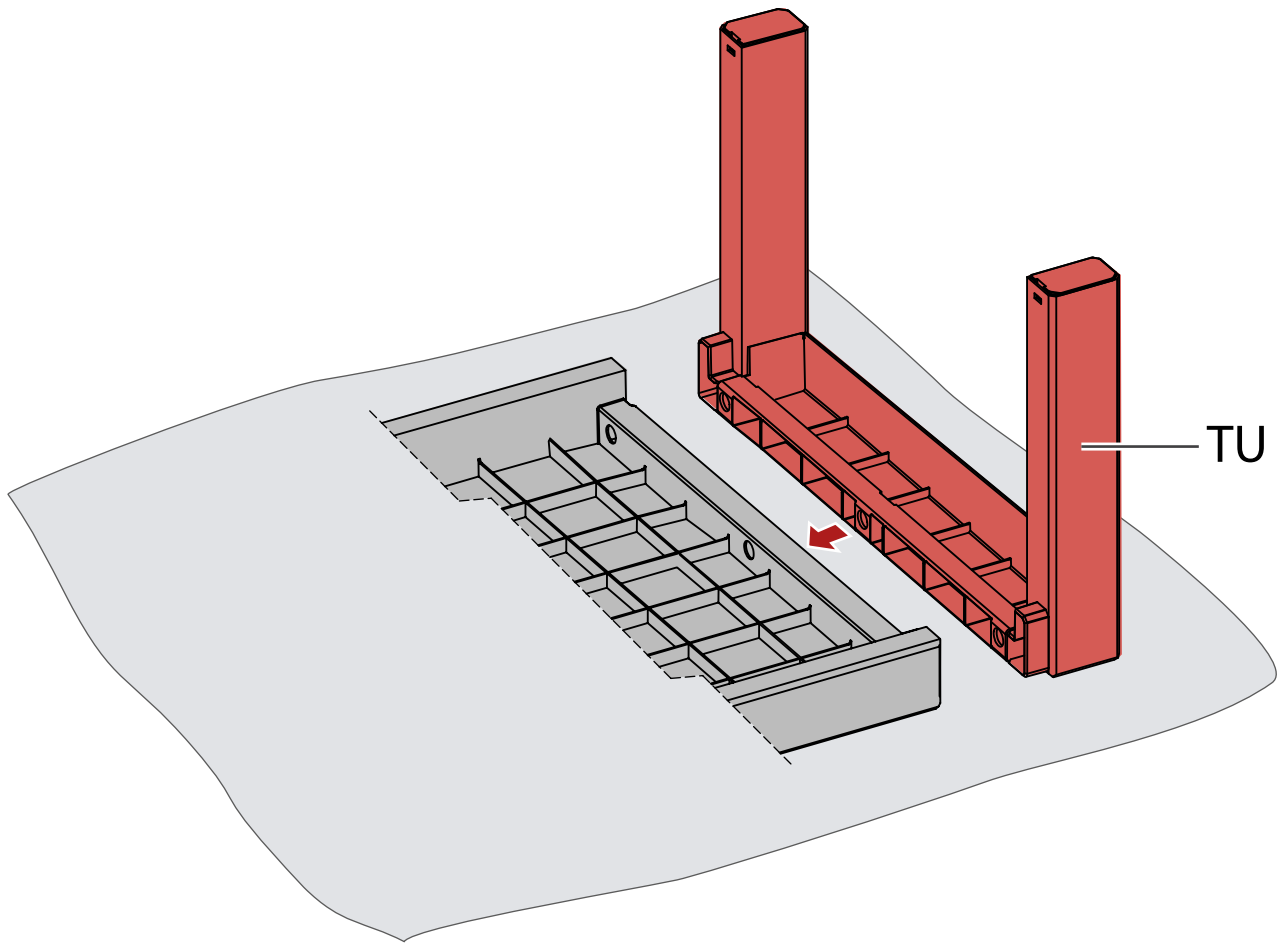

5

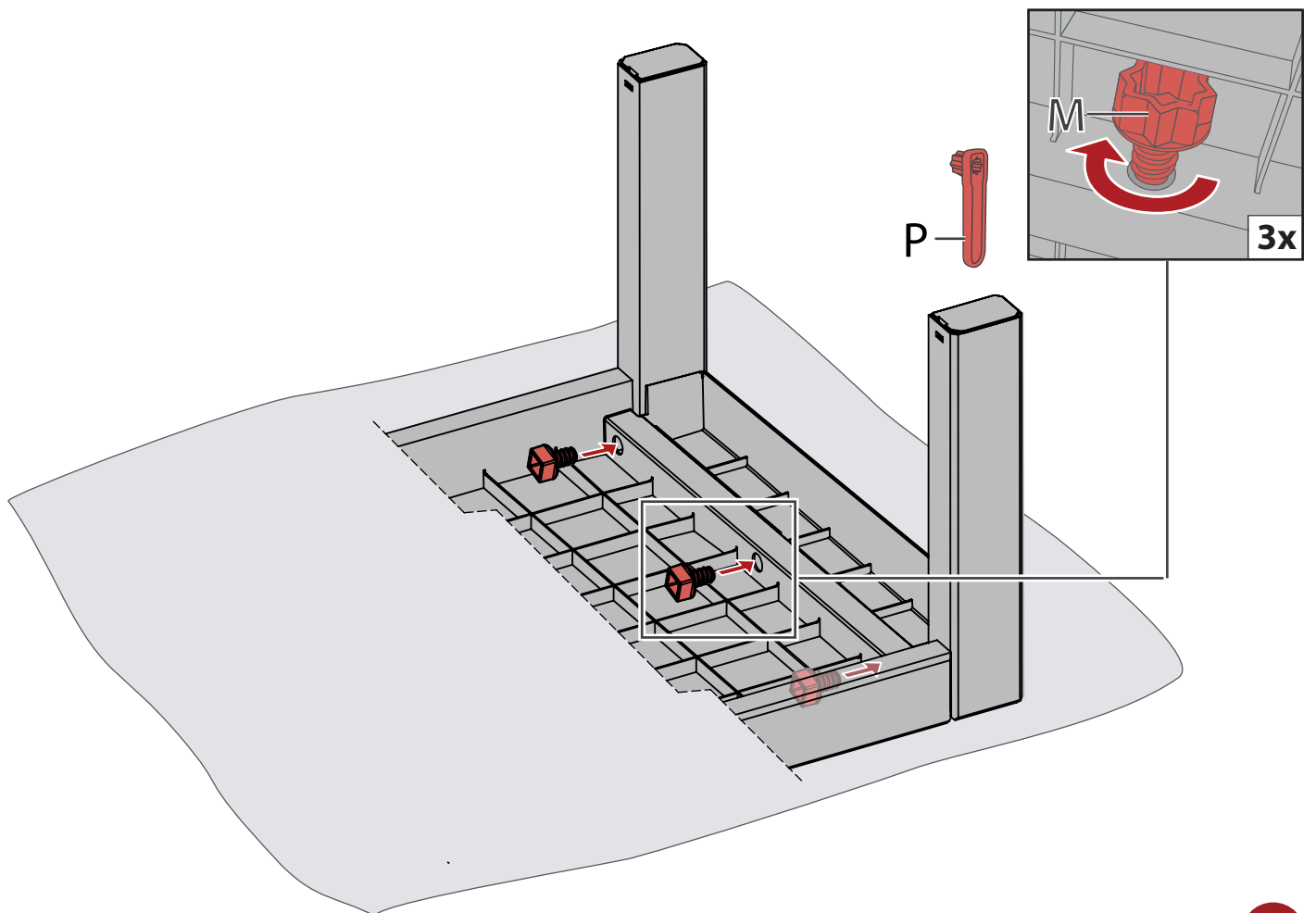

6

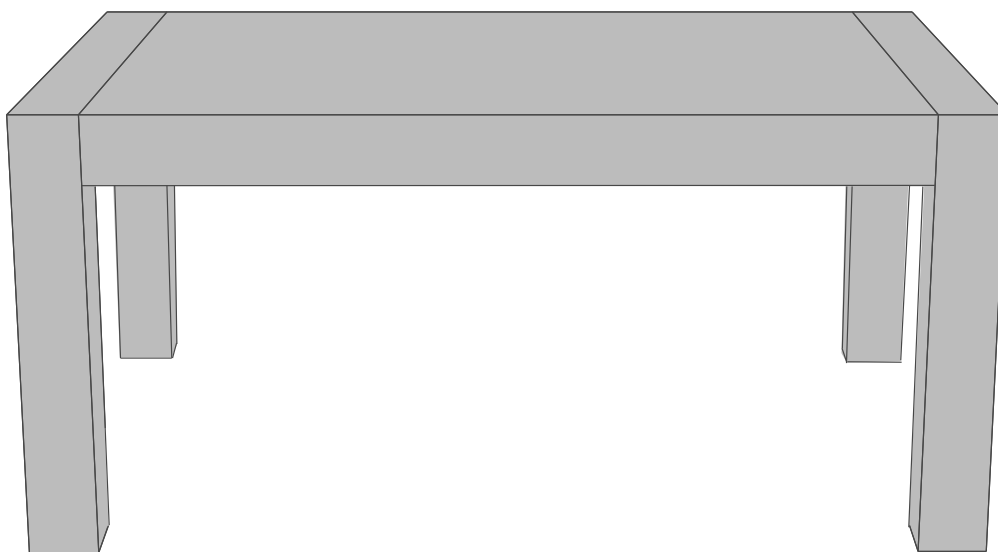

93x59cm

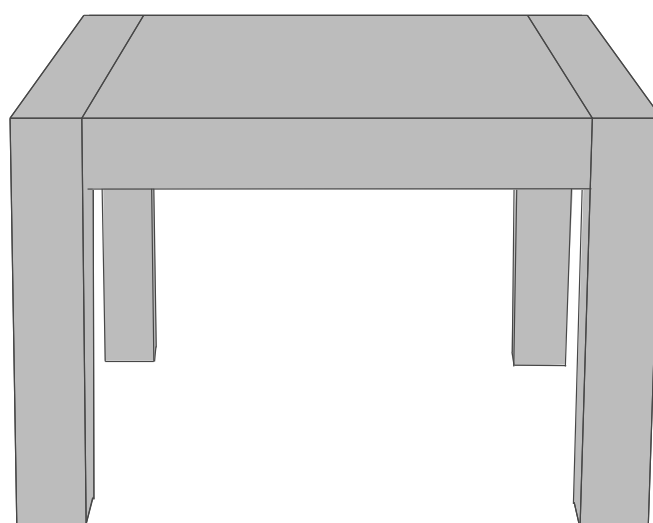

59x59cm
